

INSTRUCTIONS

PM-10AD

PHOTOMICROGRAPHIC SYSTEM

This instruction manual is for use of your instrument. Before putting it into operation, we recommend you read this manual carefully in order to familiarize yourself fully with its use so that you may obtain optimum performance.

OLYMPUS

AX5539

Proper use of the Olympus Photomicrographic System Model PM-10AD will yield optimal performance and effectiveness from this precision instrument.

Observe the following points carefully:

1. Operation

- ① Always handle the PM-10AD with as much care as you would a microscope, avoiding shock, excessive heat, cold or moisture, etc.
- ② Make sure that the position of the line voltage selector switch conforms with local voltage requirements.
- ③ Ground the instrument.
- ④ Do not strain or twist the cords.

2. Maintenance

- ① Lenses must always be kept clean. Fine dust on lens surfaces should be blown away or wiped off by means of an air blower or a clean brush. Carefully wipe off oil or fingerprints on the lens surfaces with gauze moistened with a small amount of xylene or a mixture of alcohol and ether (at the ratio of 3:7).
- ② Do not use organic solution to wipe components. Plastic parts, especially, should be cleaned with a neutral detergent.
- ③ Never try to take components apart for repair.
- ④ Make it a habit to cover the PM-10AD with a dust cover after use.

CONTENTS

I.	STANDARD CONFIGURATIONS	2
II.	IDENTIFICATION AND FUNCTION OF VARIOUS COMPONENTS	3
	A. Automatic Exposure Body	
	① Light path selector knob	
	② Diopter adjustment ring	4
	③ Focusing magnifier	
	Format indication	
	B. Automatic Exposure Control Unit	5
III.	ASSEMBLY	8
IV.	PREPARATION	13
	A. Checking the Photographic Equipment	
	B. Loading of the 35mm Film	14
	C. After Completion of the Film Roll	15
V.	OPERATING THE PM-10AD	16
	A. Photomicrography with 35mm B & W Film	
	B. Photomicrography with 35mm Color Film	17
	1. How to regulate color temperature	
	2. How to use the PM-CTR color temperature module	
	C. Special Applications	19
	1. Exposure adjustment for distribution of specimen	
	2. How to use the reciprocity failure compensation dial	
	3. Manual exposure mode	21
	4. Data imprinting photography	
	5. Use of the automatic exposure lock button (AE LOCK)	22
	6. Multiple exposures of 35mm film	
	7. Use of contrast filters (B & W)	
VI.	OPTIONAL ACCESSORIES	24
VII.	PHOTOMICROGRAPHY WITH LARGE-FORMAT CAMERA BACKS	26
	A. PM-CP 3¼" x 4¼" Polaroid Camera Back	27
	B. Intermediate Adapter for 4" x 5" Holders	29
VIII.	TROUBLESHOOTING GUIDE	31

"Polaroid" is a trademark registered by the Polaroid Corporation, Cambridge, Mass., U. S. A.

I. STANDARD CONFIGURATIONS

Model Name Component		PM-10					
		35AD -1	L1AD -1	L2AD -1	35AD -2	L1AD -2	L2AD -2
Automatic exposure body with connecting cord UYKK12	PM-PBS	○	○	○	○	○	○
Automatic exposure control unit	PM-CBAD	○	○	○	○	○	○
Power cord	UYCP	○	○	○	○	○	○
Adapter for 35mm camera back	PM-D35A	○			○		
Adapter for large format backs	PM-DL-W		○	○		○	○
35mm camera back with automatic film advance	C-35AD-4	○			○		
4" x 5" intermediate adapter	PM-C4X5-W		○			○	
3¼" x 4¼ Polaroid back	PM-CP-W			○			○
Turret mask focusing telescope	PM-VTM				○	○	○
Focusing magnifier	PM-FT-36				○	○	○
Eyepiece adapter for FK photo eyepiece	PM-ADF				○	○	○
Eyepiece adapter for P photo eyepiece	PM-ADP				○	○	○
Color temperature module	PM-CTR				○	○	○
Filter set (incl. 45LBD2N, 45LBT, 43ND6-W45 and 43ND25-W45)	PM-FIL-1	○	○	○	○	○	○

Note: ○ indicates the compatible components for the PM-10.

Optional Accessories:

- Foot switch PM-FS
- Adapter for 250 Film Back 1 PM-250AD
- Focusing telescope PM-VS
- Time lapse control unit PM-IV
- Motor drive unit for 16mm cine camera PM-MD
- Cine adapter PM-D0.4X

II. IDENTIFICATION AND FUNCTION OF VARIOUS COMPONENTS

- A. Automatic Exposure Body PM-PBS and Focusing Magnifier FT-36 (with Turret Mask Focusing Telescope PM-VTM)

Automatic exposure body PM-PBS

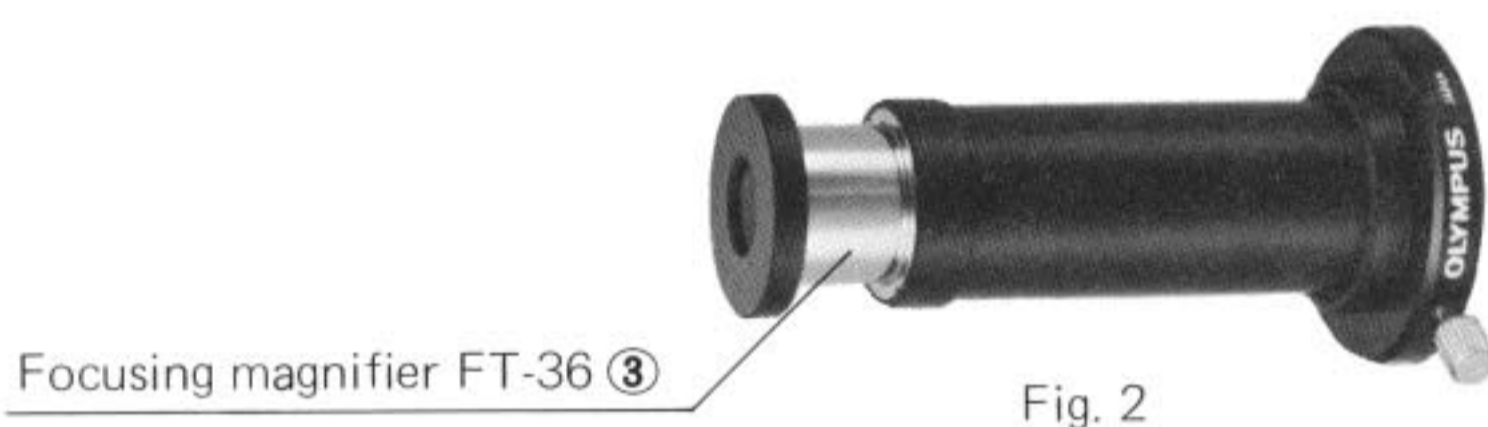
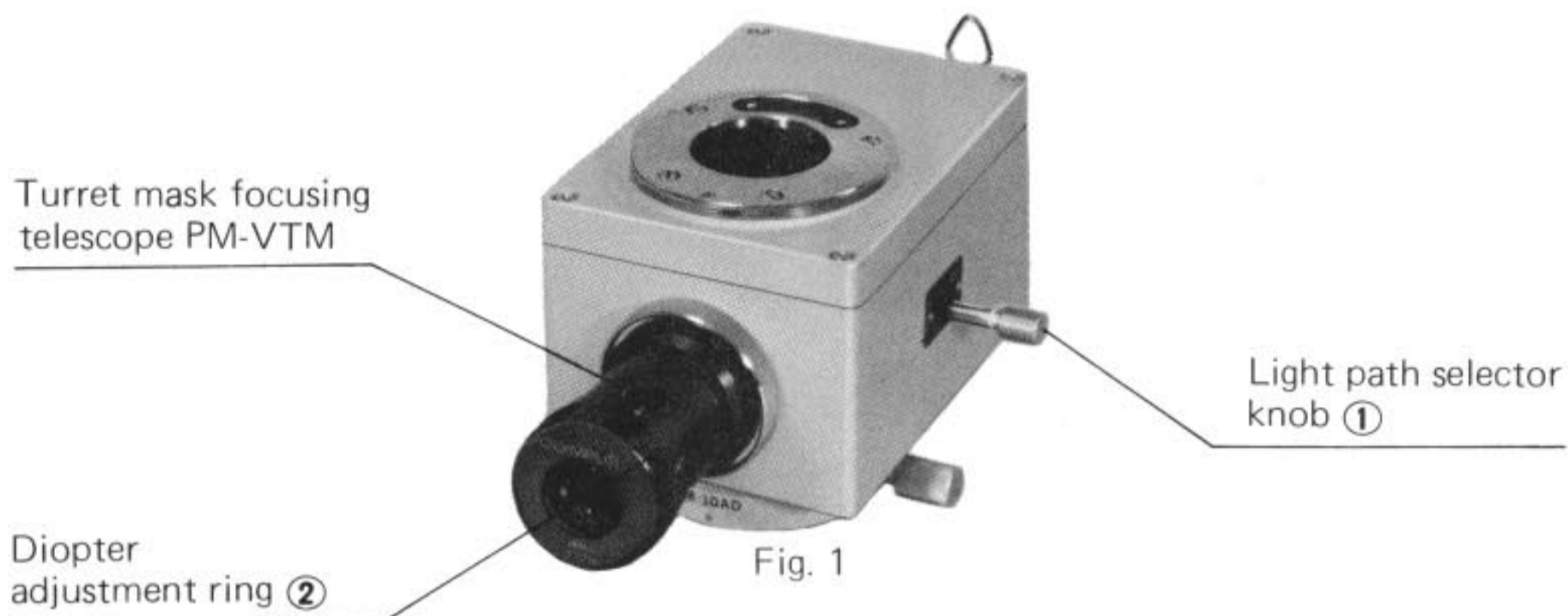

① Light path selector knob

The light path selector knob provides three different paths of light: (Fig. 1)

Knob position	Pushed in all the way (white band "CE")	Pulled out one step (green band "CVE")	Pulled out all the way (yellow band "VCT")
Light path	80% of the light goes to the film plane and 20% to the exposure regulator.	64% of the light goes to the film plane, 16% to the focusing telescope and 20% to the exposure regulator.	80% of the light goes to the telescope and 20% to the color temperature measuring unit.
Usage	Recommended for photographing dim specimens, as in darkfield, polarized light or fluorescent light.	Focusing is generally performed in this position. The shutter can be released while observing the specimen.	The color temperature indicator helps to achieve correct color balance compatible with the color film used. (Convenient for focusing when the field of view is dark.)

The indicator plate summarizing the usage of the above table is provided at the knob port; it should be consulted before operating the knob.

- CE : Camera and Exposure (white letters)
- CVE : Camera, Viewer and Exposure (green letters)
- VCT : Viewer, Color Temperature (yellow letters)

The colors of the letters correspond with the color bands on the knob shaft.

② Diometer adjustment ring

- A. Rotate the diometer adjustment ring of the turret mask focusing telescope until the cross lines in the center of the field of view are distinctly resolved as double lines. (Fig. 3)
- B. If your microscope provides the use of a finder eyepiece for focusing on the film plane, select the finder eyepiece matching the camera back in use and insert it into the right eyepiece tube of the binocular observation tube, aligning locating groove and locating pin. Then turn the front lens in screw mount to focus on the double cross lines in the finder eyepiece, similar as with the diometer adjustment ring above.

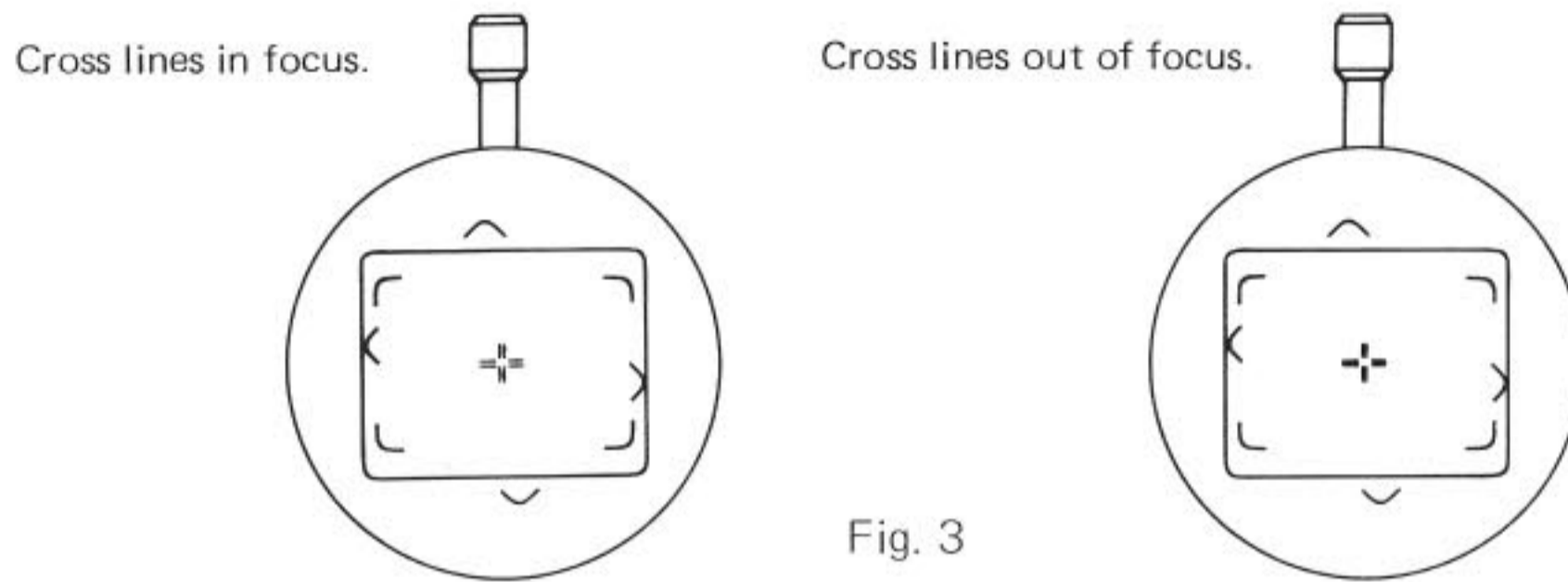

- C. As the cross lines and the film plane are in precise alignment, the image focused through the focusing telescope or the finder eyepiece and the image on the film plane are identical. Therefore, unless the adjustment just described above is exact, blurred pictures will result no matter how well the specimen may be brought in focus through the microscope.

③ Focusing magnifier FT-36

Objectives 4X or lower are difficult to focus sharply in photomicrography because of their large depth of focus. Accurate focus can be achieved by using the FT-36 in conjunction with the focusing telescope. The mounting ring of the FT-36 fits exactly over the circumference of the focusing telescope. The front lens assembly slides back and forth for focusing on the double cross line.

Format indication

Three frame reticles can be seen when looking through the turret mask focusing telescope. These reticles indicate the frame sizes for the different camera formats and represent approximately 90% of each actual picture area. Select the frame reticle by means of the mask selector lever in accordance with the camera back in use. Please note that the reticle indicating the 4" x 5" frame is fixed in the focusing telescope and cannot be rotated with the mask selector lever.

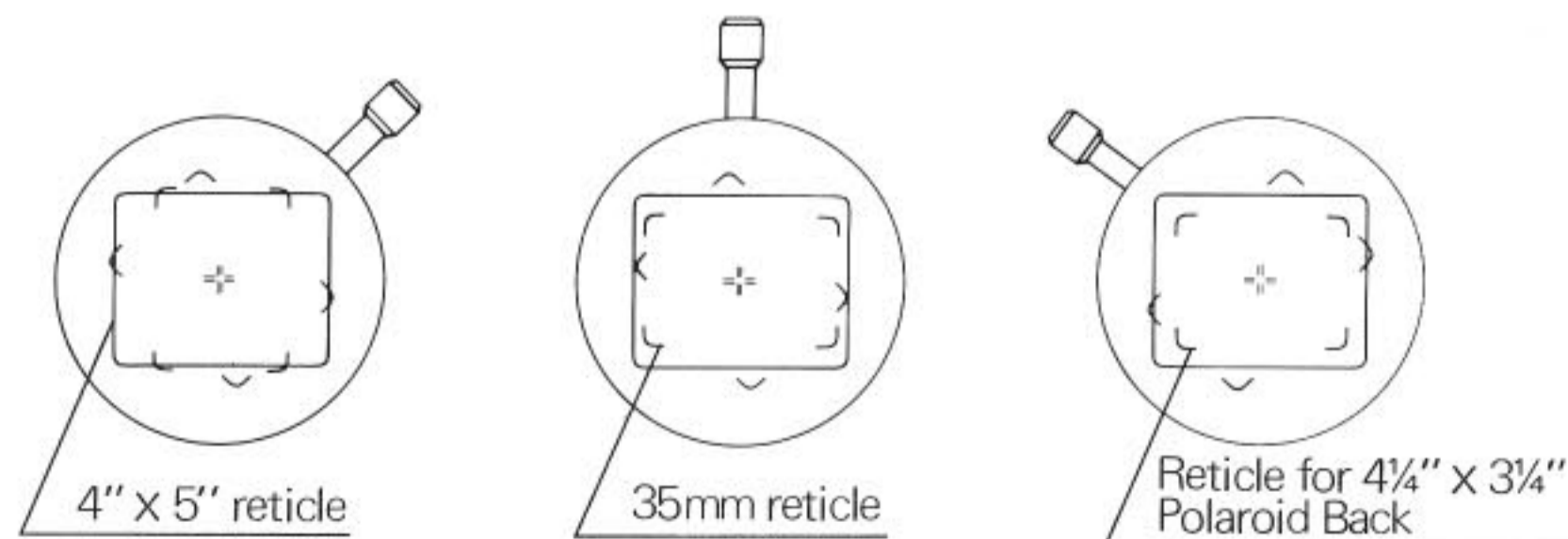

As illustrated above, moving the lever to the respective positions engraved on the focusing telescope rotates the corresponding reticles into horizontal position in the field of view.

B. Automatic Exposure Control Unit PM-CBAD

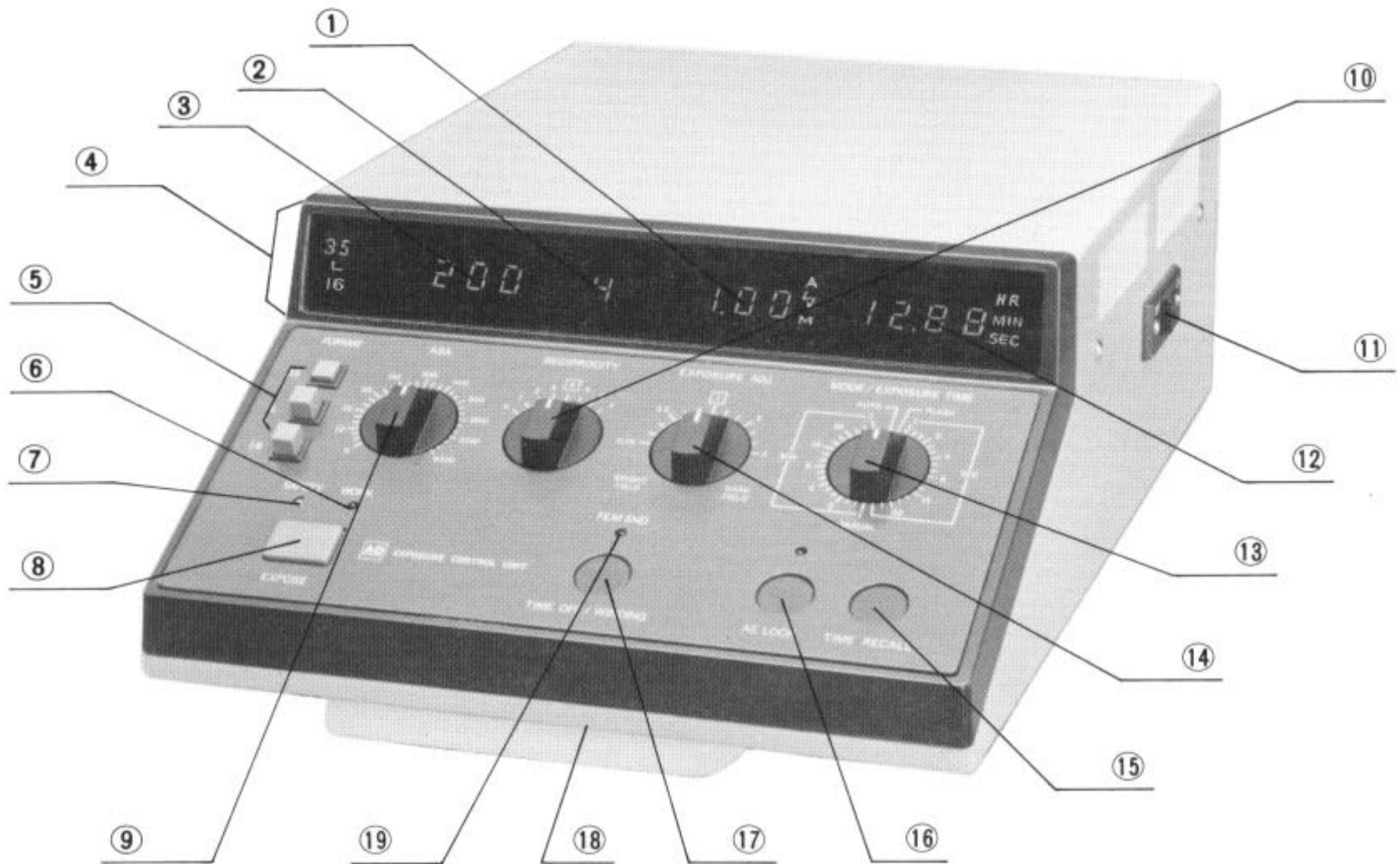

- ① Exposure adjustment display
- ② Reciprocity failure compensation display
- ③ ASA film speed display
- ④ Format display
- ⑤ Format selector switches

35 . . . for C-35AD-4 camera back.

L . . . for large format camera backs.

16 . . . for time lapse photography with Bolex 16mm cine adapter.

- ⑥ Working light (WORK) :

Lights up only while the shutter is open.

- ⑦ Safety light (SAFETY) :

Indicates whether the exposure time is within the limits of automatic exposure range.

Green light correct exposure.

Red light (blinking) . . . overexposure (plus intermittent warning beeper).

Red light on underexposure and the shutter does not close. (continuous warning tone.)

⑧ Shutter release button (EXPOSE) :

Activates the shutter.

⑨ ASA film speed dial (ASA) :

Match the dial with the film speed in use. If you set the ASA speed of the large format or 16mm film beyond the setting range on the dial, the display digits flash in warning.

⑩ Reciprocity failure compensation dial (RECIPROCITY) :

Compensates for the reciprocity failure characteristics of the film used. For details refer to the instruction sheet ⑱ provided. A setting of **4** obtains correct exposure in most cases.

⑪ ON-OFF switch

⑫ Exposure time display :

Indicates the exposure time in three stages :

(1) before exposure, it indicates the estimated exposure time.

(2) during exposure, it indicates the exposure time remaining.

(3) after exposure, it indicates the actual exposure time. The time is expressed in HR, MIN and SEC except on flash mode.

⑬ Mode selector dial (MODE/EXPOSURE TIME) :

AUTO Automatic exposure

FLASH Flash synchronizer

MANUAL . . . Any exposure time from 1 sec. to 40 min. can be preset on the timer setting dial.

The mode is shown on the LED display, ASA,  or M.

⑭ Exposure adjustment dial (EXPOSURE ADJ.) :

Exposure time can be adjusted manually according to the distribution or contrast of the specimen. The adjusted time is displayed. If the setting is beyond the working range in respect to ASA speed, the indication flashes.

Generally, correct exposure can be obtained at a setting of **1** .

⑮ Time recall button (TIME RECALL) :

The previous exposure time is displayed (for 2 sec.) by pressing this button.

⑯ Automatic exposure lock button (AE LOCK) :

Used to take photographs with the same exposure time.

⑰ Time off/film advance button (TIME OFF/WINDING) :

Closes the shutter and advances the film. If the shutter is already closed, the film is advanced. (On Auto mode, this button is not needed because the film is automatically advanced.)

⑱ Instruction sheet

⑲ Film end light (FILM END) :

Indicates the end of the roll of 35mm film in the C-35AD-4 camera back.

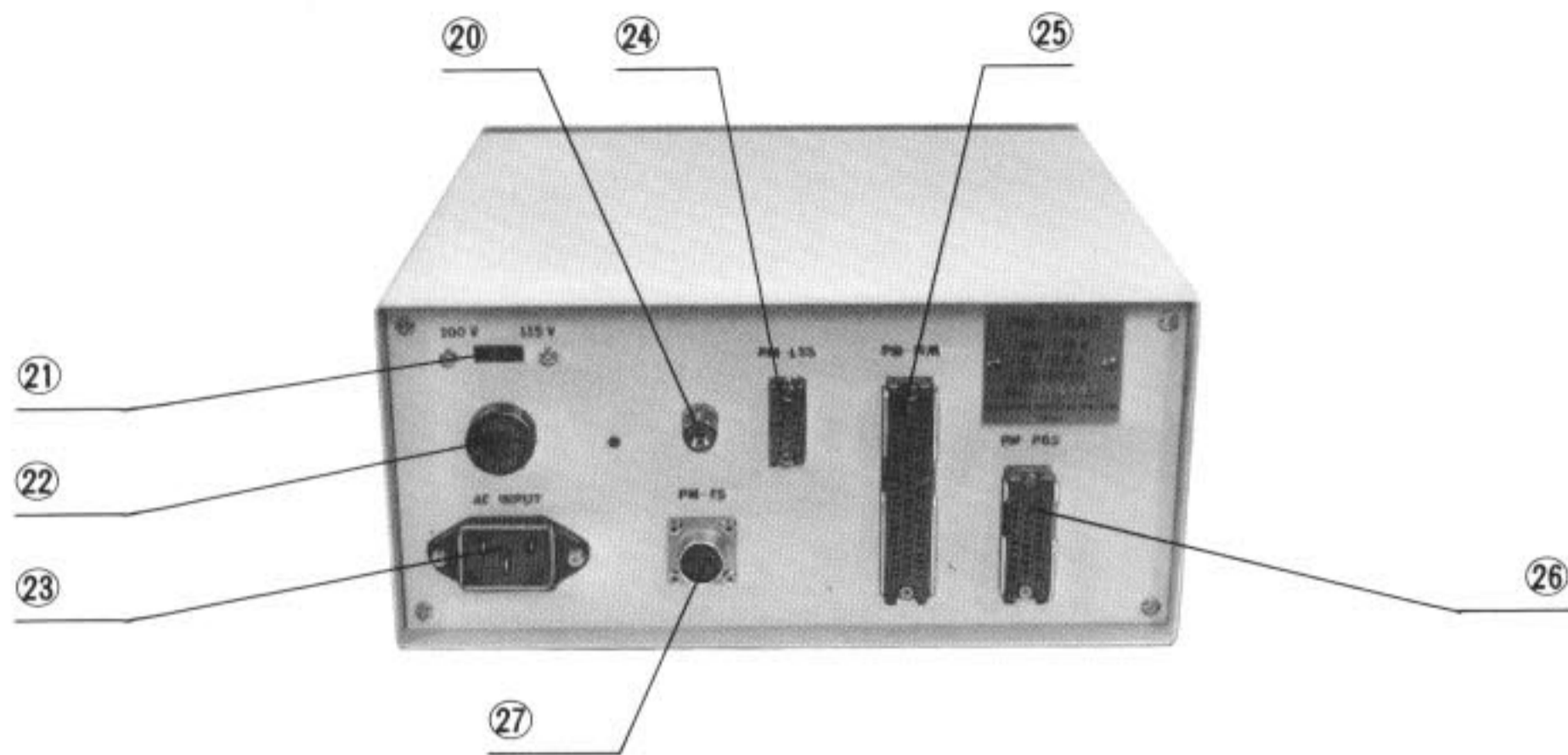

②① Terminal contact for PM-IVM :

Connects to the PM-IVM time lapse control unit.

②② Line voltage selector switch :

Set the switch to 100-115V (or 220-240V), depending on local voltage.

②③ Circuit breaker :

When there is excess current the center button pops out. After the cause for the breakdown has been located and fixed, depress the button.

②④ Line cord connector

②⑤ Low voltage cord for electronic flash PM-LSS

②⑥ Low voltage cord for time lapse photography with the PM-IVM time lapse control unit

②⑦ Low voltage cord for automatic exposure body PM-PBS

②⑧ Foot switch connector for PM-FS

III. ASSEMBLY

During assembly described below, be careful not to smudge or mar lens and prism surfaces.

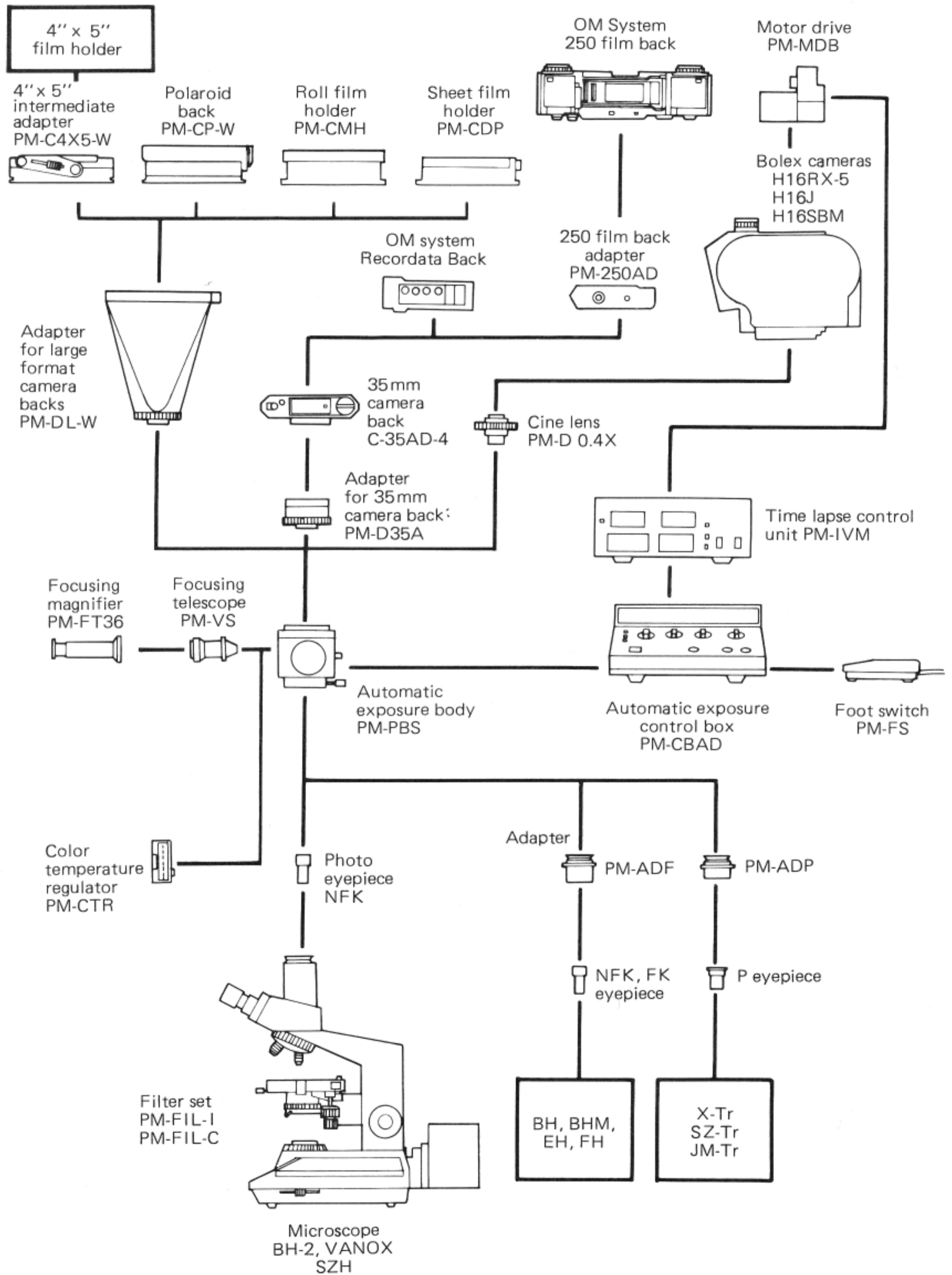

1. Attach the PM-D35A adapter for 35mm camera back to the PM-PBS automatic exposure body.

Attach to the PM-PBS ① by aligning the locating pin with the locating groove of the PM-D35A ② and clamp the adapter with the knurled clamping ring ③. (Fig. 5)

- Ⓞ The PM-DL-W adapter for large format camera backs is attached in the same way, in place of the PM-D35A.

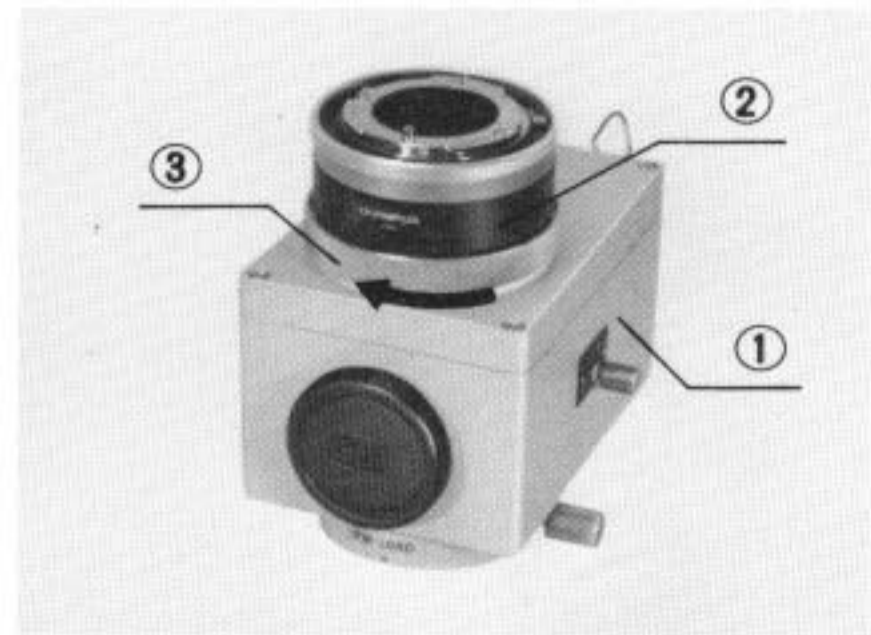
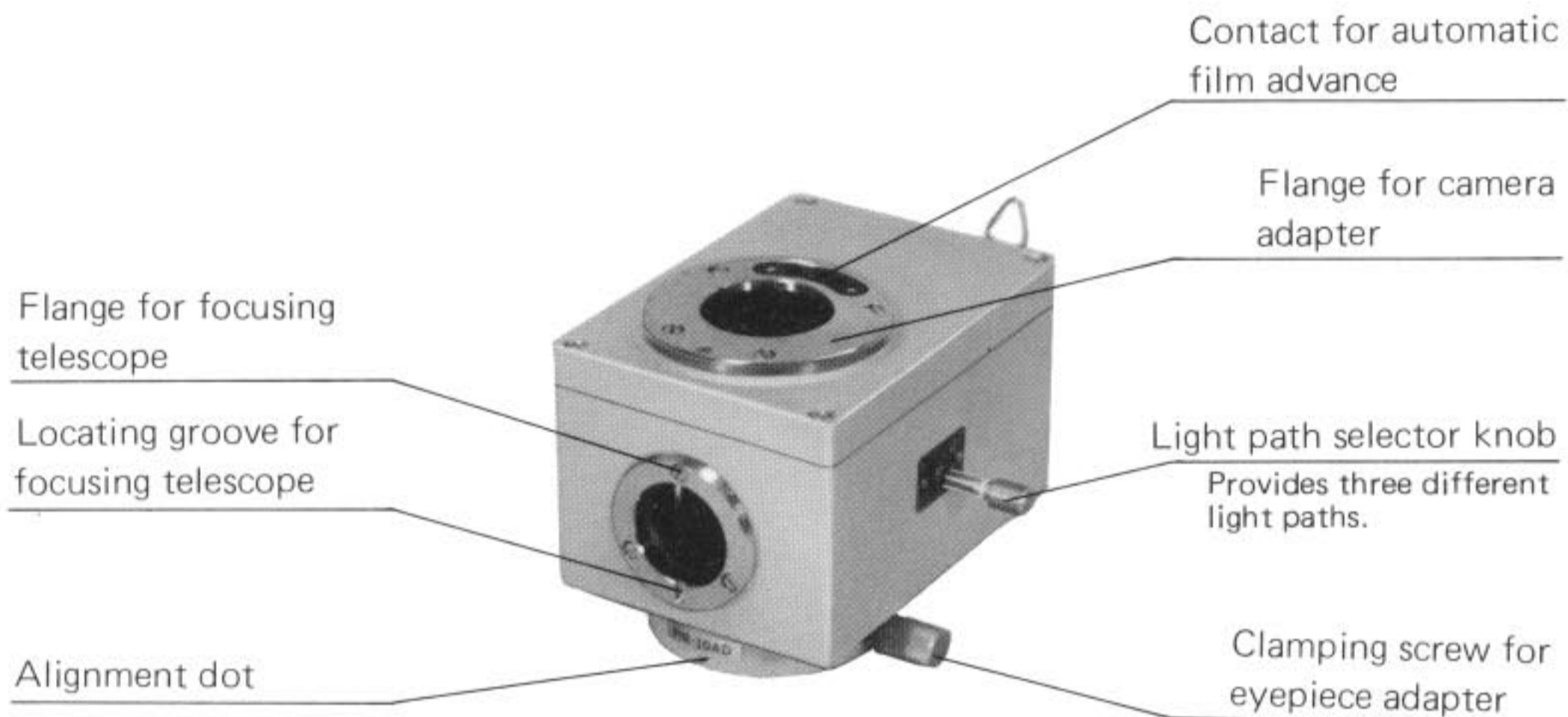

Fig. 5

Automatic exposure body PM-PBS



Adapter for 35mm camera back PM-D35A



2. Mounting the 35mm back PM-C-35AD-4.

Mount by first aligning the index dots ① on both camera back and camera adapter and rotating the camera back in the direction of the red arrow until the camera locking pin engages with an audible click. (Fig. 6)

At the same time the light excluding shutter in the camera back automatically opens.



Fig. 6

◎ Removal of the camera back

Rotate the camera back in the direction opposite to the red arrow while pressing the release lever ① at the back of the camera adapter. The camera back can be removed when the two index dots are aligned. (Fig. 7)

Prior to removal, the light excluding shutter closes to prevent light from reaching the film. However, never demount the loaded camera back-and-adapter combination from the exposure body PM-PBS, since this shutter is kept open in conjunction with the adapter.



Fig. 7

3. Attachment of the turret mask focusing telescope.

- ★ In case of the VANOX and BH-2 series microscopes, which have observation tubes designed with the constant tube length adjustment mechanisms in their observation tubes, you can bring the specimen into focus, directly looking through the right finder eyepiece without the focusing telescope. Therefore you need not uncap the flange.

Attach to the automatic exposure main body PM-PBS ① by aligning locating pin with locating groove, and clamp with the knurled ring ②. (Fig. 8)



Fig. 8

Turret mask focusing telescope PM-VTM



4. Mounting the automatic exposure body PM-PBS on the microscope.

There are two ways to mount the PM-PBS, according to the design of the observation tubes; one is to mount directly on the photo tube of the microscope such as in the VANOX or BH-2 series without any adapter, and the other is to mount by means of an adapter such as the PM-ADF or PM-ADP. (See the system chart on page 8.)

- 1) Place the PM-ADF adapter ① over the straight photo tube ② of the microscope and clamp it with the red index dot facing towards you. (Fig. 9)

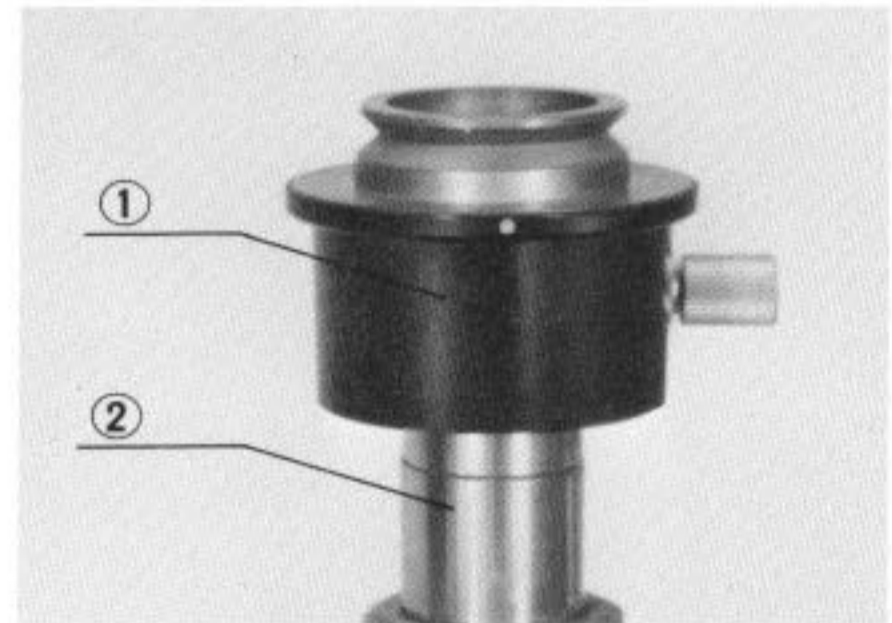

Fig. 9

- 2) Insert the FK or NFK eyepieces ① into the adapter, place the automatic exposure body on the eyepiece adapter with its index dot in line with the one of the eyepiece adapter, and clamp. (Fig. 10 & 11)

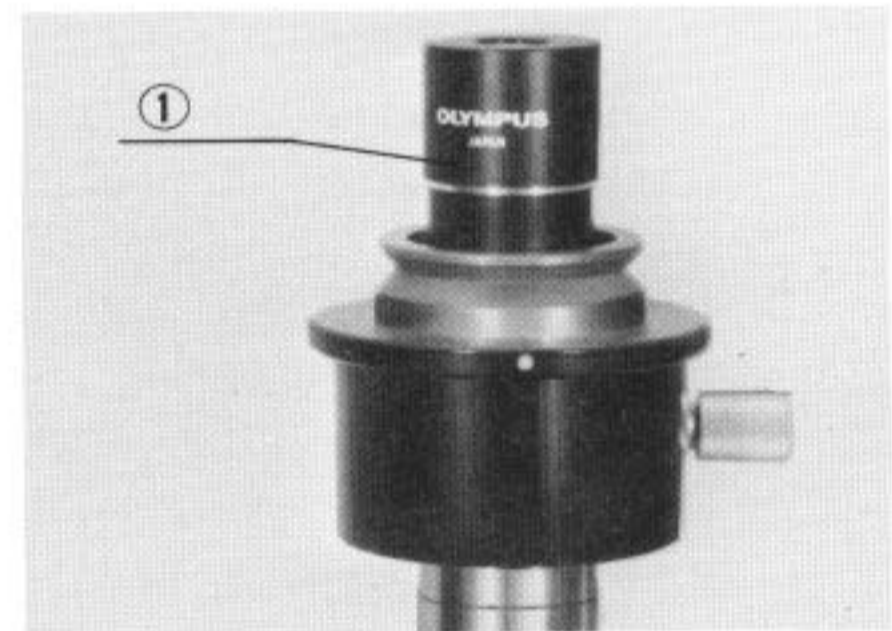

Fig. 10



Fig. 11

5. Connecting the cords.

● Low voltage connecting cord (UYKK12)

Plug the connecting cord ① into the jack at the back of the automatic exposure body and clamp with metal snap ② . (Fig. 12)

The other end of the cord connects with the receptacle at the back of the control unit (PM-PBS) ③ . (Fig. 13)

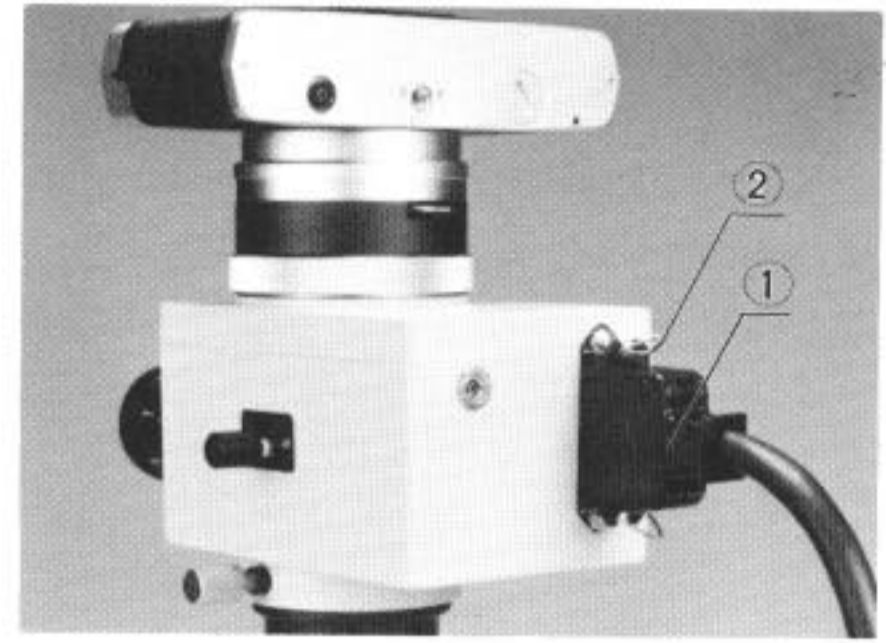

Fig. 12

● Line cord (UYCP)

Connect the mold plug of the line cord to the jack ④ at the back of the control unit and the other end of the cord to the wall outlet. (Fig. 13)



Fig. 13

6. Check to ensure that the line voltage selector switch setting is correct for local voltage.

■ Image magnifications on 35mm film plane

1) FK and NFK photo eyepieces : Objective magnif. x FK (or NFK) photo eyepiece magnif.

2) P eyepieces : Objective magnif. x P eyepiece magnif. x 0.5

Obj. \ Eyepiece	FK(NFK) 2.5X	FK(NFK) 3.3X	FK(NFK) 5X	FK(NFK) 6.7X	P7X	P10X	P15X
1 X	2.5X	3.3X	5 X	6.7X	3.5X	5 X	7.5X
1.3X	3.3X	4.3X	6.5X	8.7X	4.6X	6.5X	9.8X
2 X	5 X	6.6X	10 X	13.4X	7 X	10 X	30 X
2.5X	6.3X	8.3X	12.5X	16.8X	8.8X	12.5X	18.8X
4 X	10 X	13.2X	20 X	26.8X	14 X	20 X	30 X
5 X	12.5X	16.5X	25 X	33.5X	17.5X	25 X	37.5X
10 X	25 X	33 X	50 X	67 X	35 X	50 X	75 X
20 X	50 X	66 X	100 X	134 X	70 X	100 X	150 X
40 X	100 X	132 X	200 X	270 X	140 X	200 X	300 X
50 X	125 X	165 X	250 X	335 X	175X	250 X	375 X
60 X	150 X	198 X	300 X	402 X	210 X	300 X	450 X
100 X	250 X	330 X	500 X	670 X	350 X	500 X	750 X

IV . PREPARATION

A. Checking the Photographic Equipment

Before film-loading, familiarize yourself thoroughly with the operation of all components by checking the following steps :

After pulling out the light path selector knob one step (green band "CVE"), setting the MODE/EXPOSURE TIME switch of the control unit to the "AUTO" position and adjusting the ASA speed dial setting to the speed of the film in use, make sure that the following conditions are satisfied :

- 1) The SAFETY light (green) ① is ON. (Fig. 14)
- 2) The WORK light ② goes on when the center of the shutter release button ③ is gently pressed. (The light can be seen only while the shutter is open.)

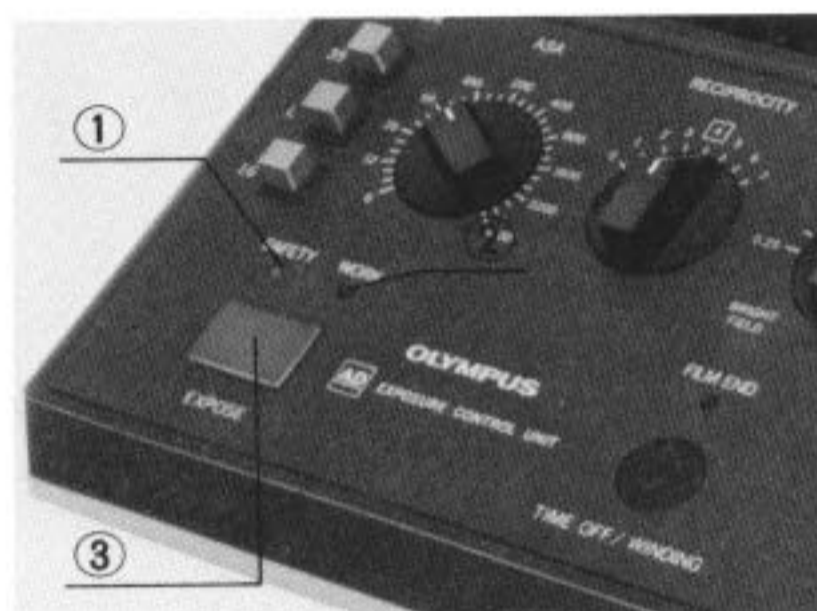

Fig. 14

Phenomenon	Possible cause	Remedy
Complete failure of 1) and 2)	Incomplete connection of cords	Check and secure cord connections.
SAFETY light (red) goes on (simultaneously with warning tone).	Light intensity is too high.	Reduce intensity.
WORK light does not light up while the shutter is open.	Light intensity, and consequently shutter speed, is so high that the eye cannot detect the brief flicker of the WORK light.	Reduce intensity.
SAFETY Light (red) goes on (with continuous warning tone).	Light intensity is too low.	Increase intensity.

- 3) When the shutter closes, the WORK light goes out, immediately followed by film advance, during which process the WINDING light on the camera back goes on. At the same time, a slight motor drive sound is audible.

B. Loading of the 35mm Film

It is possible to load or unload the camera while it is mounted on the automatic exposure body.

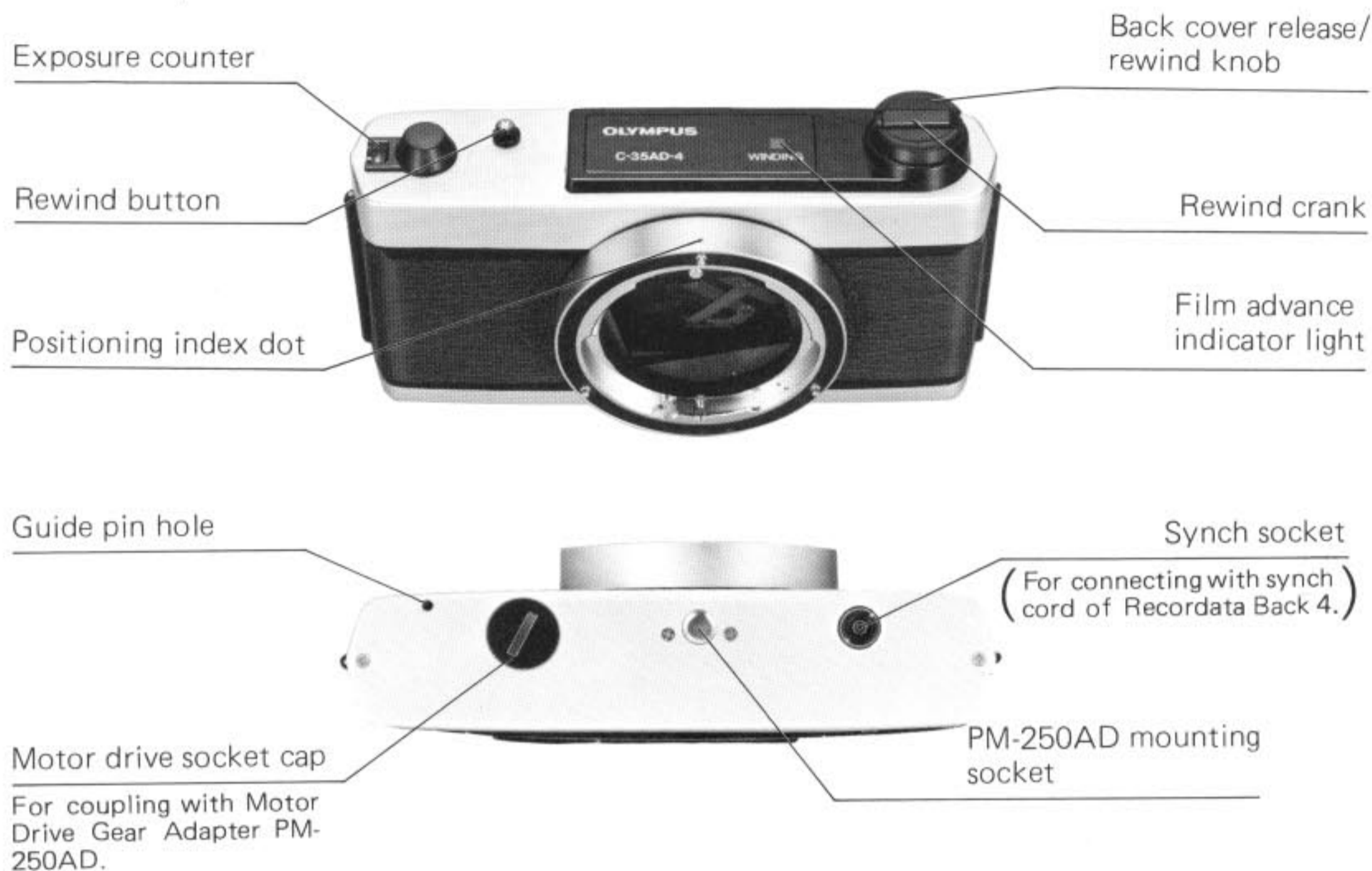

1) Lift up the rewind crank ① folded into the rewind knob. A slight resistance may be felt before the back cover (hinged cover) snaps partially open. (Fig. 15)

2) Put the cartridge ① in the film chamber and push the rewind knob back into position. (Fig. 16)

3) Insert the film end into a slit on the take-up spool ②. (Fig. 16)

Watch that the end of the film does not protrude from the opposite side of the slit.

★ If the film is loaded with the camera body detached, mount the camera back on the adapter on top of the PM-PBS exposure body at this step.

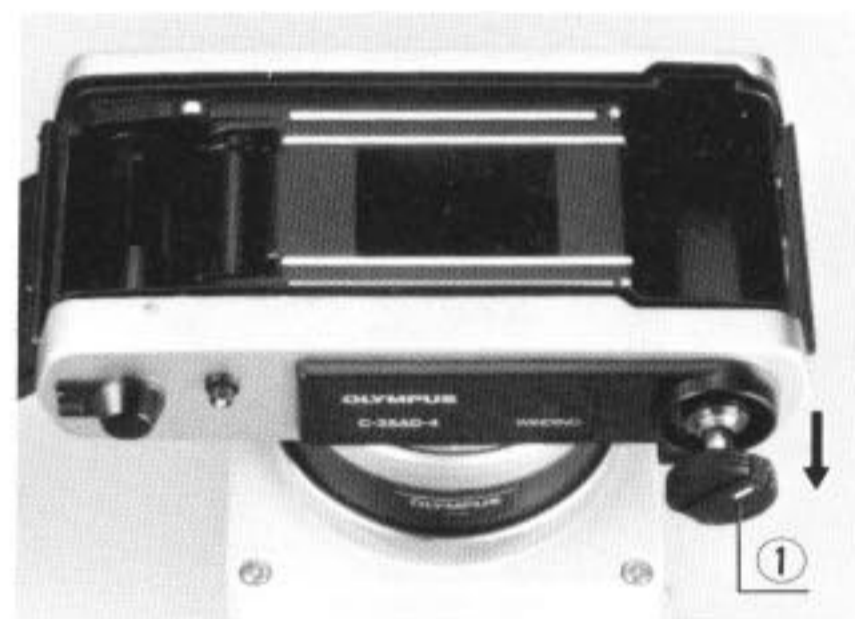

Fig. 15

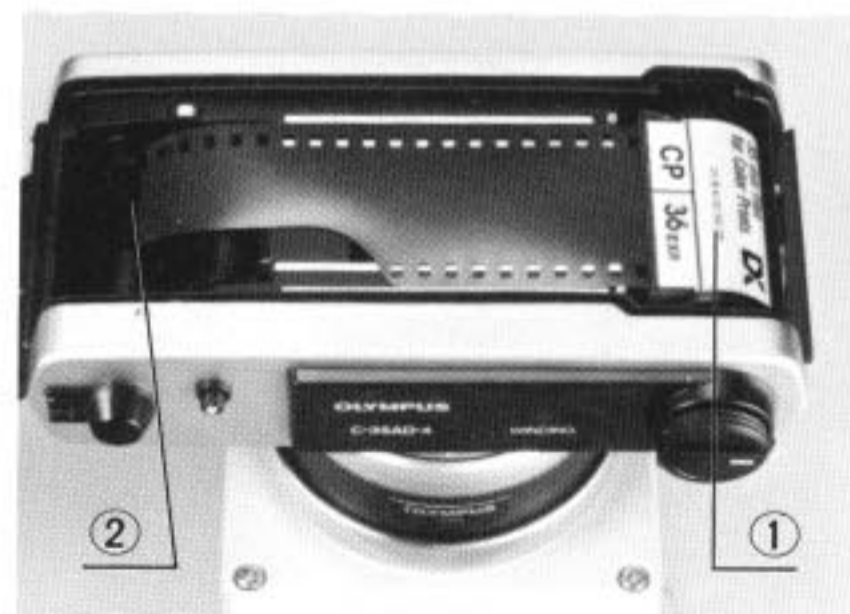

Fig. 16

- 4) Press the film advance button (TIME OFF/WINDING) on the control unit and advance the film until the film perforations engage the sprockets ① on both sides. (Fig. 17)

The film is advanced by one frame each time the advance button is pressed.

- 5) Close the back cover and press until a click can be heard.

- 6) Press the film advance button again to advance the film (2 to 3 frames) until the number 1 appears in the exposure counter.

- 7) It is convenient to insert the end flap of the 35mm film package into the memo holder provided on the camera back cover as a reminder of the type of film used.

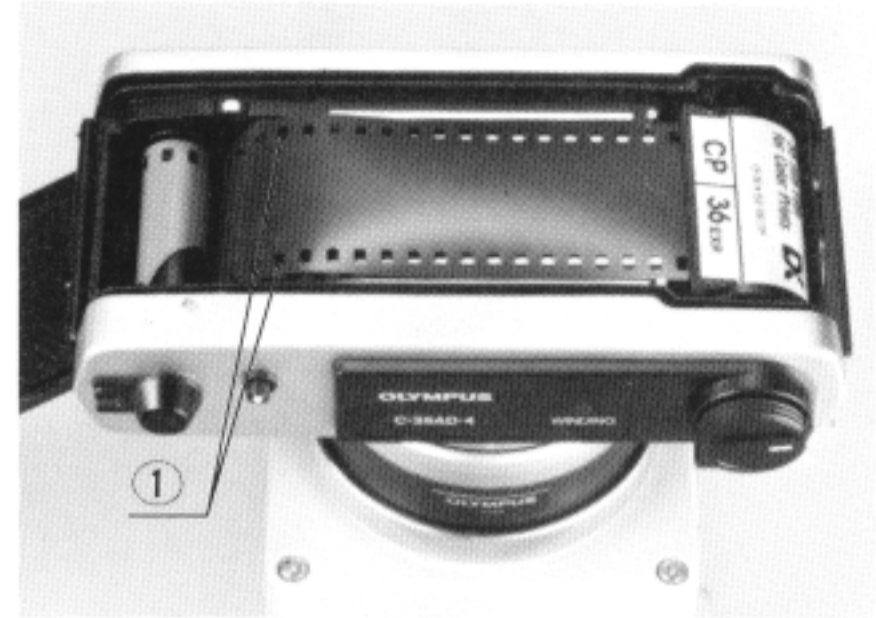

Fig. 17

C. After Completion of the Film Roll

- 1) As soon as all the frames in a roll have been exposed, the film advance motor stops, the FILM END light on the control unit lights up and the warning tone sounds.

★ You can stop the warning tone by pressing the TIME OFF button after either rewinding and unloading the film or removing the camera.

- 2) Press the rewind button ① atop the camera back. (Fig. 18)

- 3) Fold out the rewind crank ② and wind it in the direction of the arrow (clockwise). (Fig. 18) While rewinding, you will feel tension. When the tension stops and the crank turns freely, the film has been completely rewound back into the cartridge.

★ The rewind button will automatically return to its original position after the film has been completely rewound.

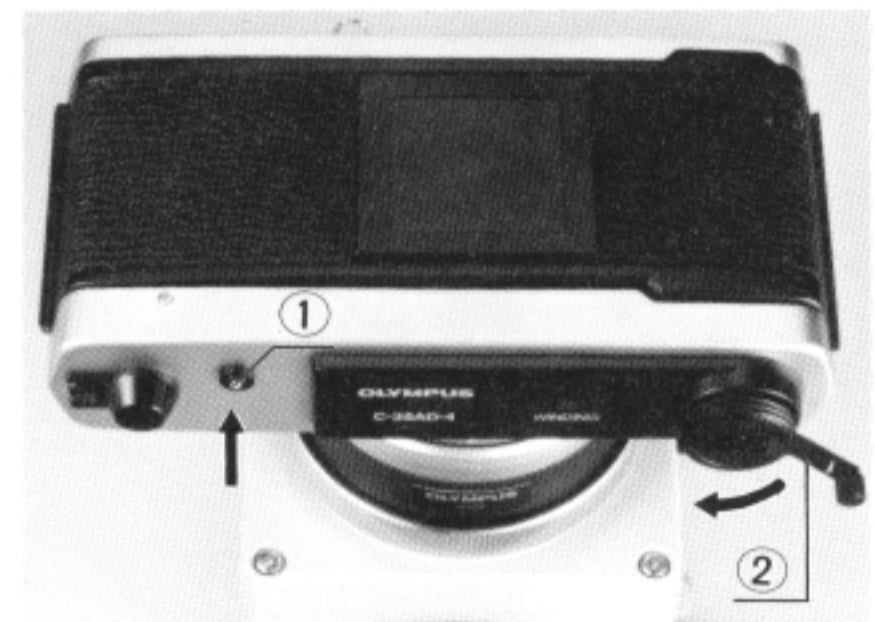

Fig. 18

V. OPERATING THE PM-10AD

A. Photomicrography with 35mm B & W Film

- 1) Ascertain that the MODE/EXPOSURE TIME switch ① is set at AUTO. (Fig. 19)
- 2) Press the "35" FORMAT selector switch ①. (Fig. 20)
- 3) Set the ASA dial to the speed of the film in use. (Fig. 20)
(In Fig. 20 the dial is set for an ASA 200.)
- 4) Adjust the RECIPROCITY dial ③ according to the characteristics of the film. (Fig. 20)
Refer to the instruction sheet provided, by sliding the plastic sheet out from under the control box. A setting position ④ generally obtains optimal exposure.

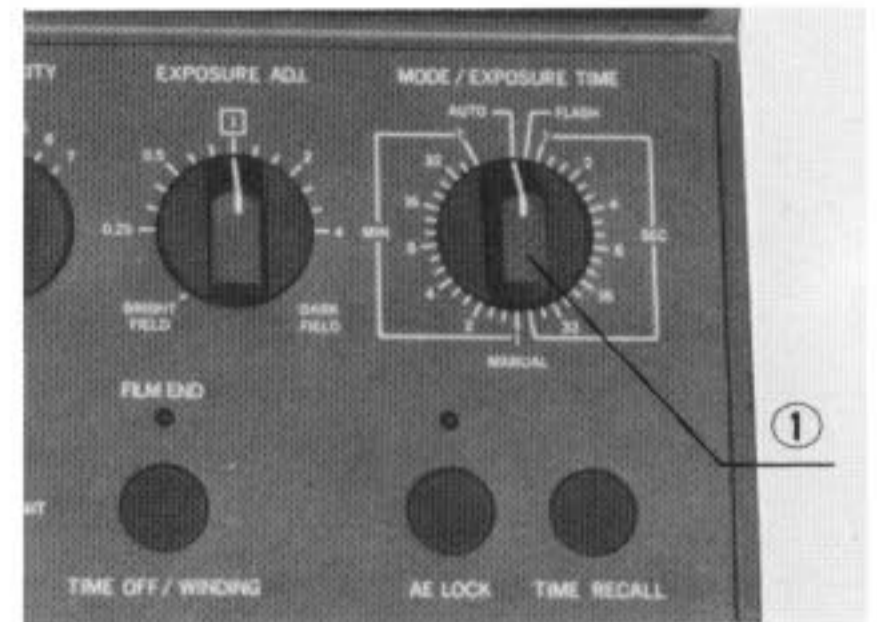

Fig. 19

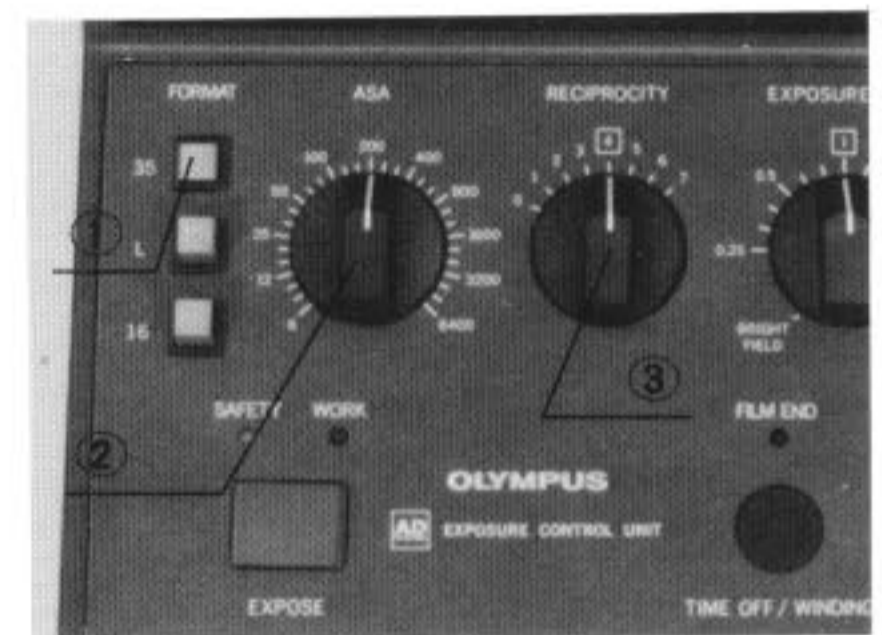

Fig. 20

- 5) Check that the SAFETY light (green) is on.
In case of abnormal conditions, the red light lights up instead of the green. Check as follows to see to it that the green light goes on as normal.
 - If the red warning light blinks Overexposure ; use ND (neutral density) filters to reduce light intensity.
(with intermittent warning sound) **Caution:** If voltage is decreased, the illumination may become too red, causing incorrect exposure.
 - If the red light goes on continuously Underexposure. Check the illuminator; increase intensity.
(with intermittent warning sound)
- 6) Set the EXPOSURE ADJ. dial.
A setting of ① is recommended for a specimen evenly spread throughout the field of view, permitting high transmittance in brightfield illumination. If the specimen is unevenly spread, consult the exposure adjustment method on page 19 .
- 7) Release the shutter by pressing the exposure button on the control box. The WORK light appears for the duration of the exposure.
When the exposure is finished, it goes out, and immediately the film is automatically advanced to the next frame.

B. Photomicrography with 35mm Color Film

Photomicrography with color film is basically the same as with black and white film, but for best results the color temperature of the light source should be the same as the one for which the film was manufactured.

1. How to regulate color temperature.

In the case of Olympus microscopes with a voltmeter, you can perform photomicrography with color temperature compensation filters as described in the attached insertion.

2. How to use the PM-CTR color temperature module

1) Mounting the module.

- a) Take off the left-hand side cover of the automatic exposure body by pulling up the lever provided at the lower end of the cover.
- b) Attach the module by means of the clamping screw ① of the module, using a coin to lock it firmly. (Fig. 21)

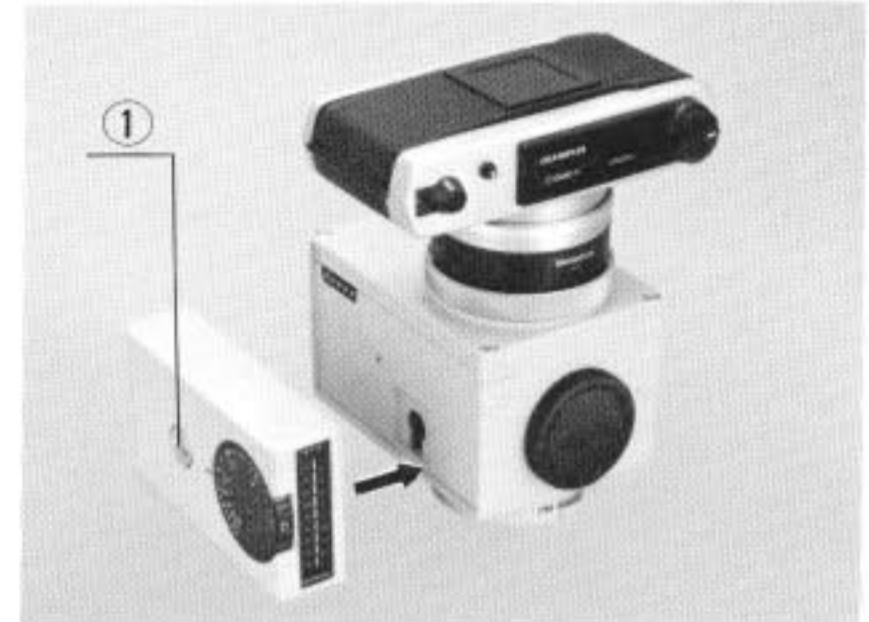

Fig. 21

2) Regulating the color temperature.

- a) Focus on the specimen, then move the specimen slide until a portion of the slide without any specimen covers the field of view. (Fig. 22)
- ★ Accurate regulation of the color temperature is impossible when the specimen is in the field of view, therefore bring into the field an area such as that circled in Fig. 22.

- b) Pull the light path selector knob out all the way, to the yellow band. (Fig. 23)

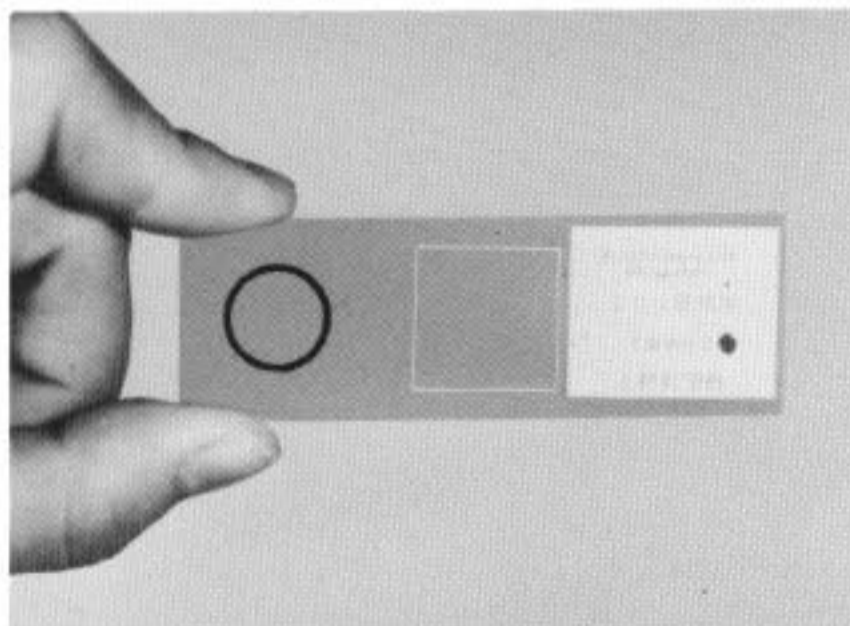

Fig. 22



Fig. 23

- c) Set the color temperature module dial ① to D (for daylight type) or, T (tungsten type) depending on the type of film used. (Fig. 24)

The array of vertically aligned color squares □ is used to finely adjust the color temperature of the light source for constant color rendition with different types of emulsion used on film or according to your preference for a particular color reproduction effect. (The dial is approximately graduated in increments of 10 mireds.) The squares above the central triangle indicate higher color temperature, below the triangle indicate lower color temperature.

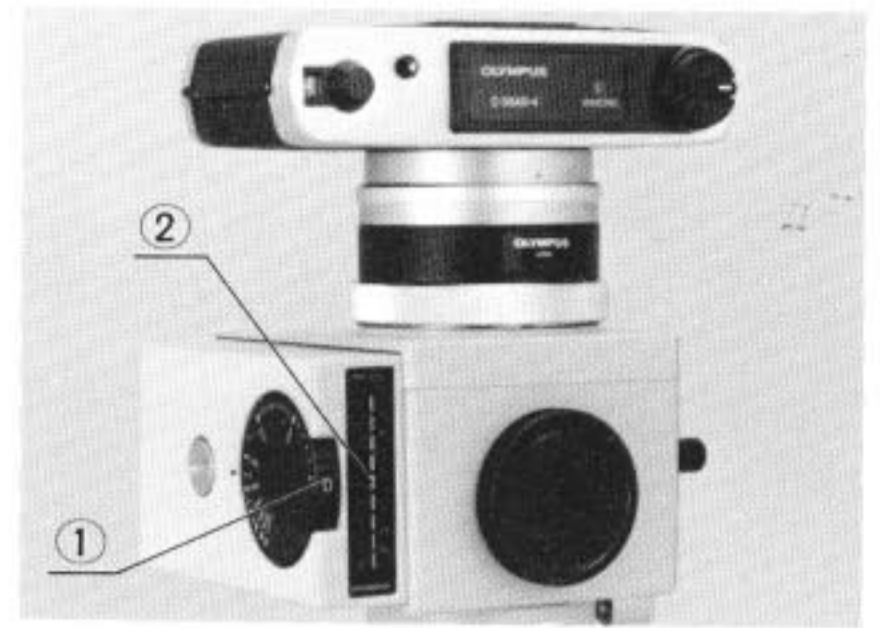

Fig. 24

- d) For tungsten type film, insert an LBT filter in the filter mount on the microscope base, and for daylight type film, the LBD-2 filter. Adjust the illuminator's voltage until the digital indicator lamp ② lights up at the triangle (yellow).

- ★ The green light goes on The color temperature of the light source is higher than the designated color temperature of the film.
- ★ The red light goes on The color temperature of the light source is lower than the designated color temperature.

- e) Push in the light path selector knob by one step (green band "CVE"). Thereafter the procedure is the same as that described for photomicrography with 35mm B & W film.

- ★ After regulating the color temperature do not alter the LBD-2 or LBT filter and the voltage of the light source. Use neutral density filters (ND) to regulate the light intensity, if necessary.

C. Special Applications

The special applications introduced here can help to produce improved photomicrographs under certain conditions.

1. Exposure adjustment for distribution of specimen.

Exposure can be adjusted using the adjustment dial for a wide range of specimen contrast patterns; for example, only small portions of specimen exhibit intense brightness, e.g. dark field or fluorescence illumination, etc., or low contrast chromosomes in bright field illumination, etc.

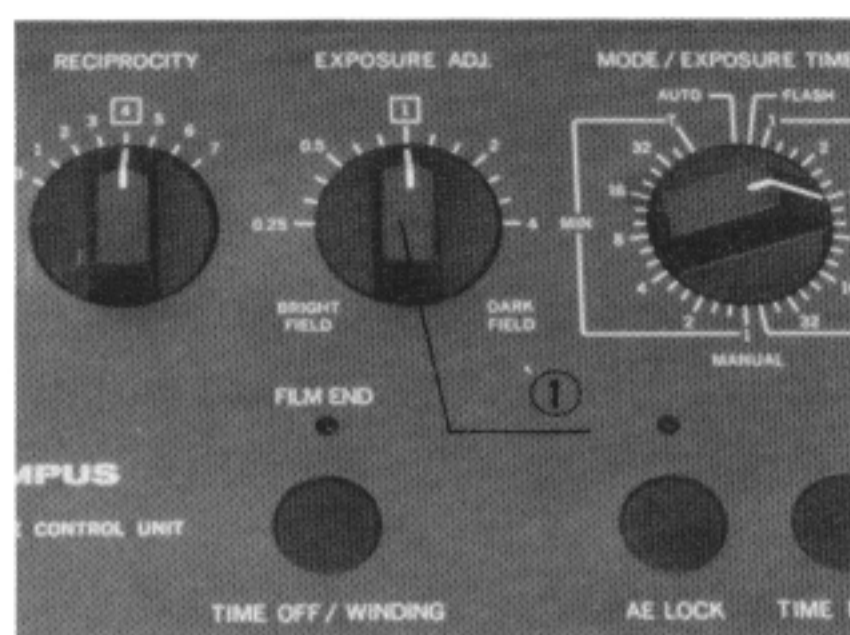

© Color reproduction of transparency slides (positive film)

- Commercially available color compensation filters (CC filters) can also be used to slightly improve color reproduction.
They are roughly categorized in 3 groups as follows :

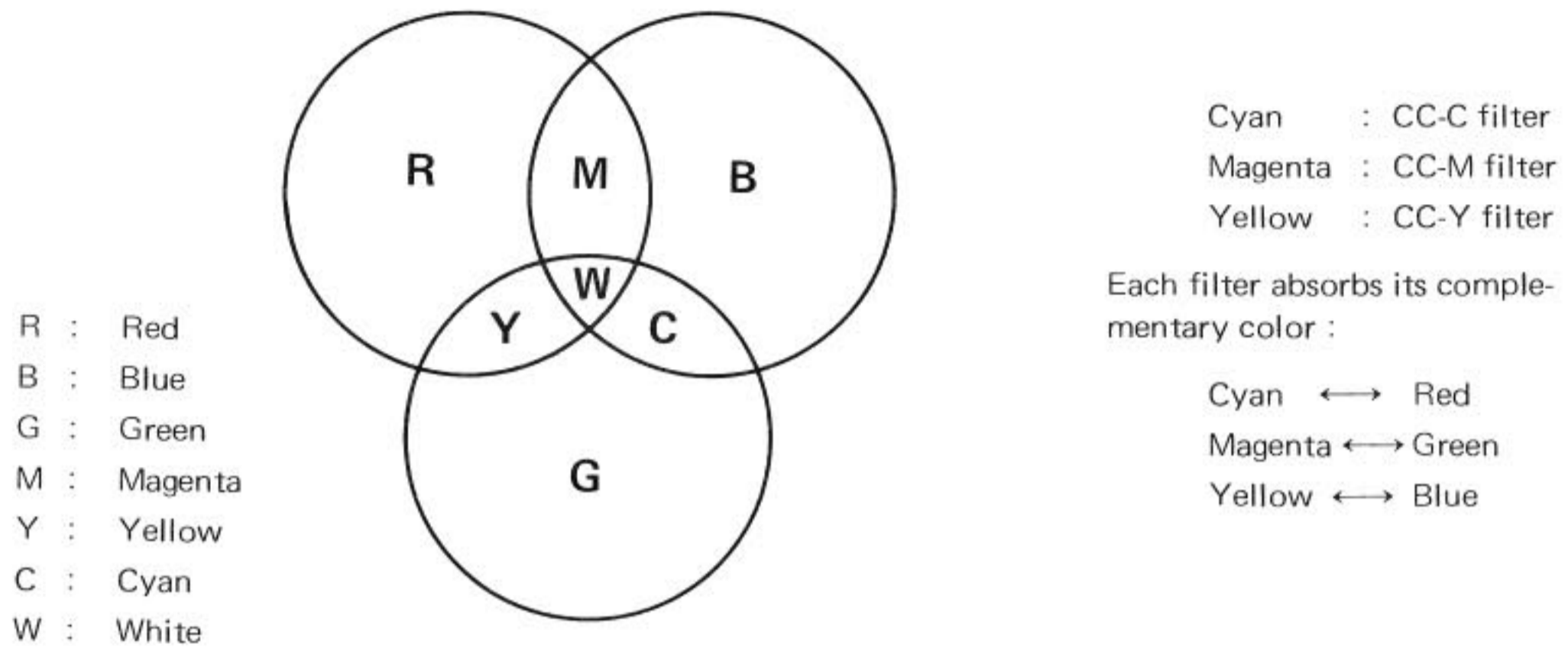

- The color density of a CC filter is indicated by the filter number. As the number increases, so does the density.
In case of magenta filters, CC-M5, CC-M10, CC-M15, etc. are available. For photomicrography, numbers 5 to 15 are recommended.
- When examining a correctly exposed transparency, there is a color which you wish to eliminate, use an appropriate CC filter.
As a practical means of selecting the filter, you can approximate the result by placing a CC filter over the slide on an light box. Then you can take a picture with a suitable CC filter, using the same conditions as for the original slide.
- Even the same brand of film can have slightly different color reproduction characteristics, depending on the emulsion numbers. Therefore it is convenient to stock a large amount of the same brand and type of film in a refrigerator so that you can use film with the same number every time you make photomicrographs. (Before use, the film must be brought to room temperature.)

3. Manual exposure mode

Exposure time can be selected manually without utilizing the automatic exposure system. This enables you to choose exposure times yourself, including long exposures beyond the limits of the auto exposure range.

- 1) Select shutter speed from 1 sec. through 40 min. on the mode selector switch (MODE/EXPOSURE TIME). (Fig. 26)
 - 2) Press the shutter release button (EXPOSE). The shutter will open for the preset time.
- ★ If an exposure longer than 40 minutes is required, set the mode selector switch at "T", and press the shutter release button. The shutter will stay open until the "time off" button is pressed (TIME OFF/WINDING).

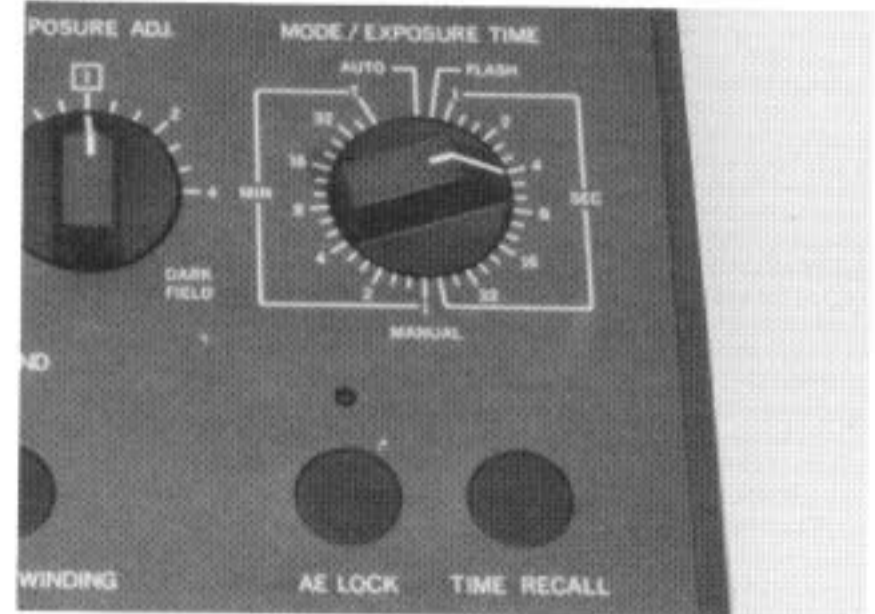

Fig. 26

4. Data imprinting photography

- 1) Connect the synchronization cord of the Recordata Back to the X contact ① on the automatic exposure body. (Fig. 27)
- ★ When using the recordata back 4, the connecting cord (UYK25) is necessary (option).
- 2) Follow the instruction manual provided with the Recordata Back.
 - 3) The imprint positions are indicated in the half tone areas in the diagrams below :

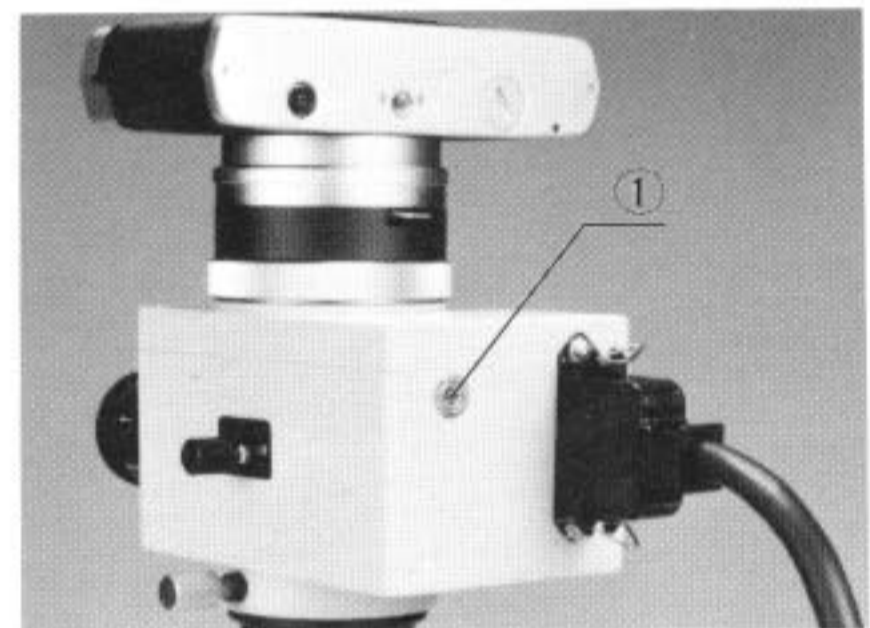
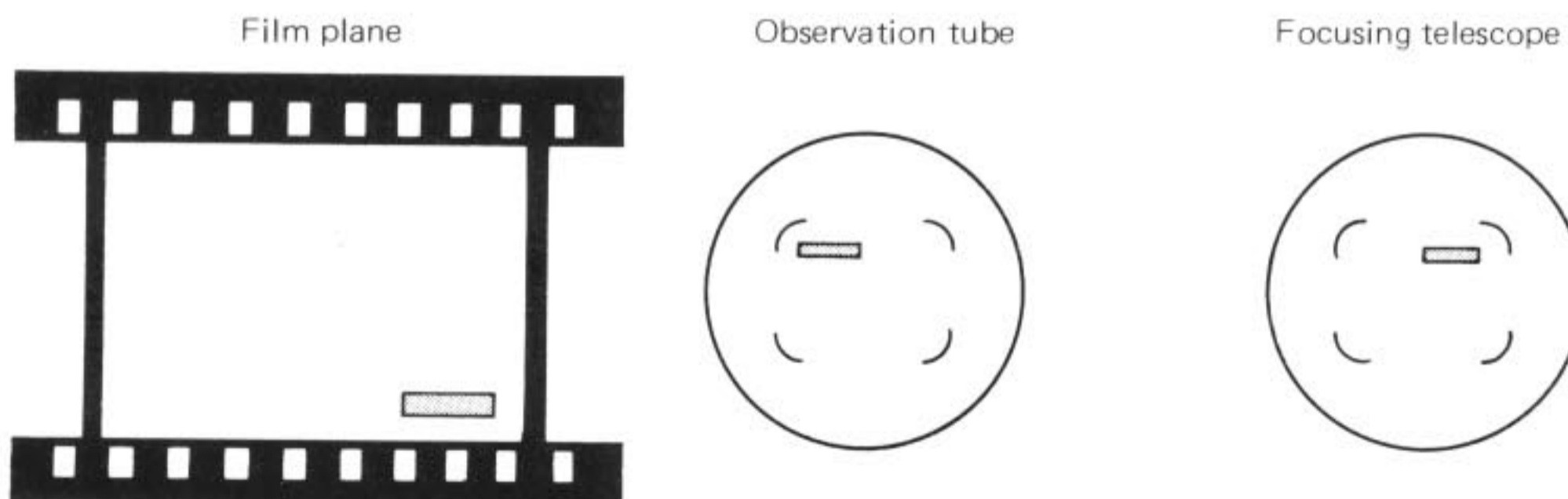

Fig. 27



The imprint position of the lower right corner of the film is recognized at the top left of the field of view through the observation tube and at the top right through the focusing telescope, therefore, watch out for correct composition and framing.

5. Use of the automatic exposure lock button (AE LOCK)

This feature can be used to obtain uniform exposure times (i.e. backgrounds) and is convenient in photomicrography of the same object in different compositions or in panorama photography, with multiple photographs taken under identical exposure conditions.

- 1) After selection of a representative area of the specimen, the AE LOCK button is pressed, and the exposure time is locked in for subsequent exposures until the AE LOCK is pressed again.

While the exposure time is locked, the TIME RECALL light will flash.

6. Multiple exposures of 35mm film

Multiple exposures of the same frame can be made by releasing the automatic film advance system in the following way :

- 1) Set the ASA film speed dial to a value 8 times the actual speed of the film (i.e. in the case of ASA 100, to ASA 800).

- 2) Press the format selector switch "L".

Repeated automatic exposures can now be made without the film advancing.

- ★ The ASA film speed is set at a higher value to reduce exposure time and avoid over-exposure.

To advance the film, press the "35" format selector switch and then the film advance button.

7. Use of contrast filters (B & W)

Contrast filters should be selected according to the specimen staining method. They are used under the following conditions :

- Light source voltage : 12V lamp at 7V or higher.
6V lamp at 4V or higher.
- Filter position : In the light exit mount of the microscope base
- ND filter : Adjusts light intensity; this method is preferable to adjustment by voltage control in order to obtain consistent results at the same voltage.
- Film : Neopan F, Panatomic X are recommended for their fine grain.
- Processing (guideline) : D-76, 1 : 1, at 20°C ... Neopan F 11 min.
Panatomic X 7 min.
- Exposure factor : 1 X

■ Contrast Filters for Various Dyes

Filter Dye	Green 45G-530	Red 45O-560
Orange G	○	
Azocarmine G	○	
Eosin	○	
Acid fuchsin	○	
Aniline blue	○	○
Hematoxylin	○	○
Methylene blue		○
Light green SF		○

■ Contrast Filters compatible with method of staining

Filter Staining	Green 45G-530	Red 45O-560
H. E.	○	X
Giemsa	○	X
Azan	○	△*
M. G.	○	○
Papanicolaou	△**	△**

Remarks: X Not compatible.
 ○ Compatible.
 △ Variable, depending on purpose.

Notes: △* The opposite of the above phenomenon.
 △** As results of staining vary according to cells, different filters should be used according to the situation.

VI. OPTIONAL ACCESSORIES

A. PM-250AD Motor-drive Gear Adapter for 250 Film Back 1

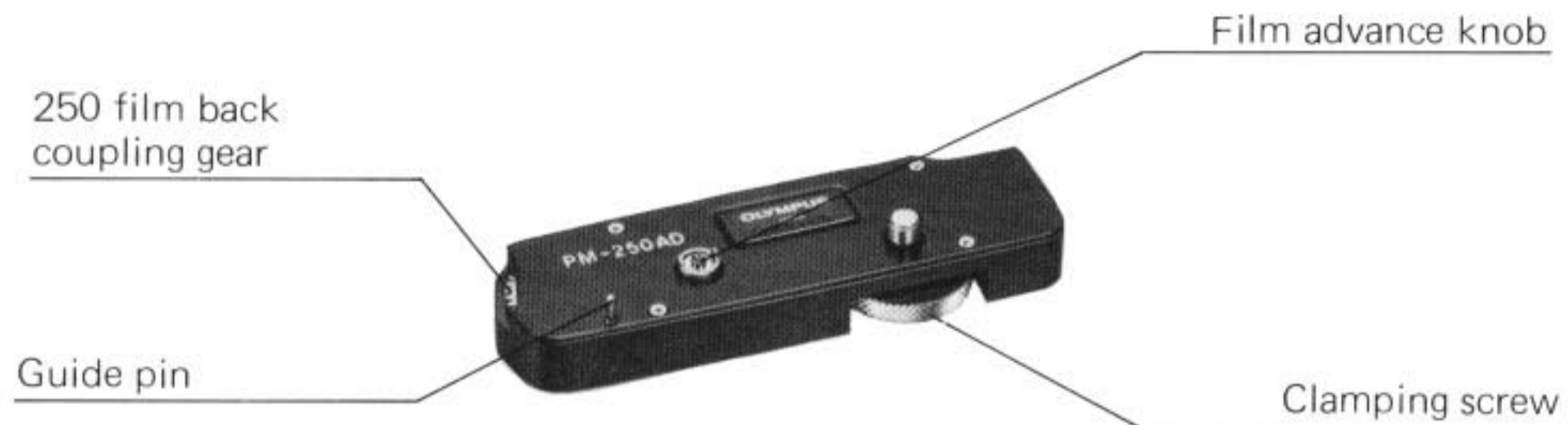

This adapter connects the bulk film magazine (250 Film Back 1) to the camera back.

B. PM-DL Adapter for Large-Format Camera Backs

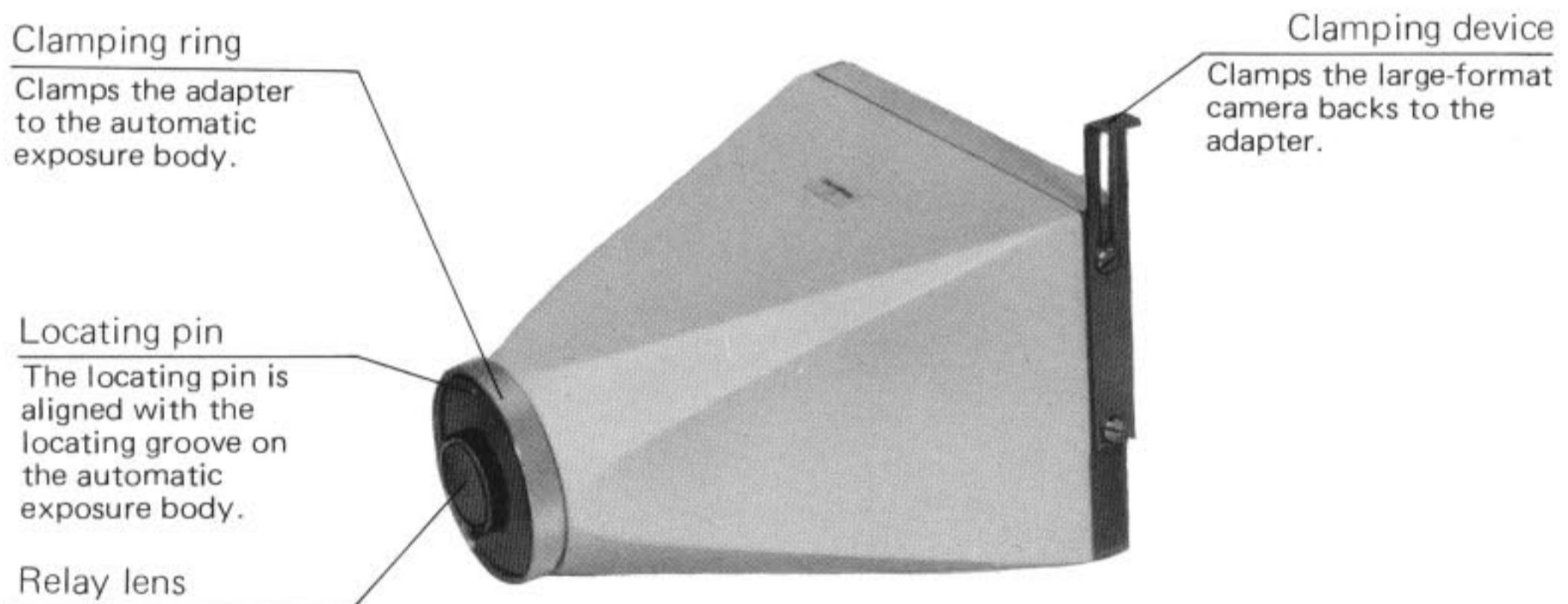

The adapter is required for all types of large-format camera backs.

C. Large-format Camera Backs

1. PM-CP Polaroid 3¼" X 4¼" Back



2. PM-C4X5 Intermediate Adapter for 4" X 5" Holders

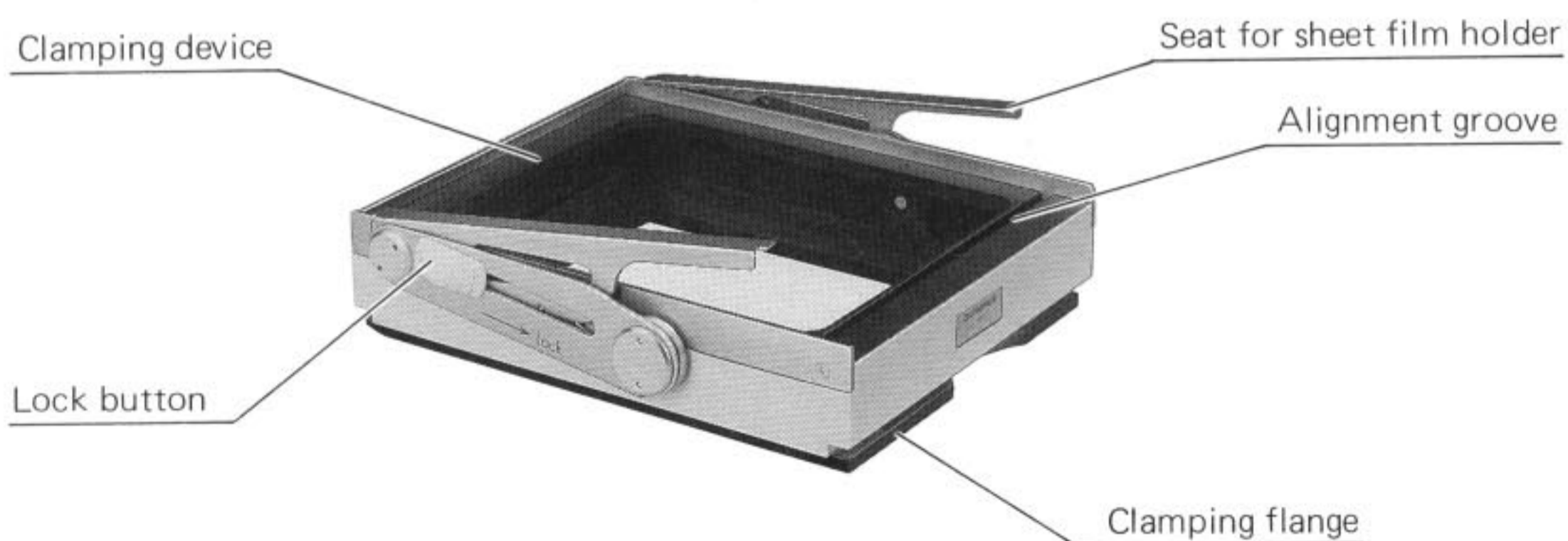

VII. PHOTOMICROGRAPHY WITH LARGE-FORMAT CAMERA BACKS

Replace the 35mm camera adapter with the large-format adapter and mount the large format camera back. The picture size varies with the type of camera back used, but the magnification at the film surface remains the same for all, as follows :



* If FK or NFK photo eyepieces are used :

Objective magnification X NFK or FK photo eyepiece magnification X 3

* If a P eyepiece is used :

Objective magnification X P eyepiece magnification X about 1.5

From the foregoing, the magnifications as tabulated below may be obtained by combining the objectives and eyepieces available.

Eyepiece Objective	FK(NFK)				P		
	2.5X	3.3X	5X	6.7X	7X	10X	15X
1 X	7.5X	10 X	15 X	20 X	10.5X	15 X	22.5X
1.3X	9.8X	12.5X	19.5X	26 X	13.7X	19.5X	29 X
2 X	15 X	20 X	30 X	40 X	21 X	30 X	45 X
2.5X	18.8X	25 X	37.5X	50 X	26 X	37.5X	56 X
4 X	30 X	40 X	60 X	80 X	42 X	60 X	90 X
5 X	37.5X	50 X	75 X	100 X	52.5X	75 X	112.5X
10 X	75 X	100 X	150 X	200 X	105 X	150 X	225 X
20 X	150 X	200 X	300 X	400 X	210 X	300 X	450 X
40 X	300 X	400 X	600 X	800 X	420 X	600 X	900 X
50 X	375 X	495 X	750 X	1005 X	525 X	750 X	1125 X
60 X	450 X	594 X	900 X	1200 X	630 X	900 X	1350 X
100 X	750 X	1000 X	1500 X	2000 X	1050 X	1500 X	2250 X

A. PM-CP 3¼" X 4¼" Polaroid Camera Back

Picture size : 3¼" X 4¼" (73mm X 95mm)

Film used : Polaroid Type 668 (Color, ASA 75)
Polaroid Type 667 (B & W, ASA 3000)

1. Loading the camera back with Polaroid

After reading the film pack instructions :

- 1) Open the film case and take out the film pack.
- 2) Push the cover locking latch ① upwards with both hands. (Fig. 28)
- 3) Open the camera back cover all the way. (Handle with care so as not to break the cover.)

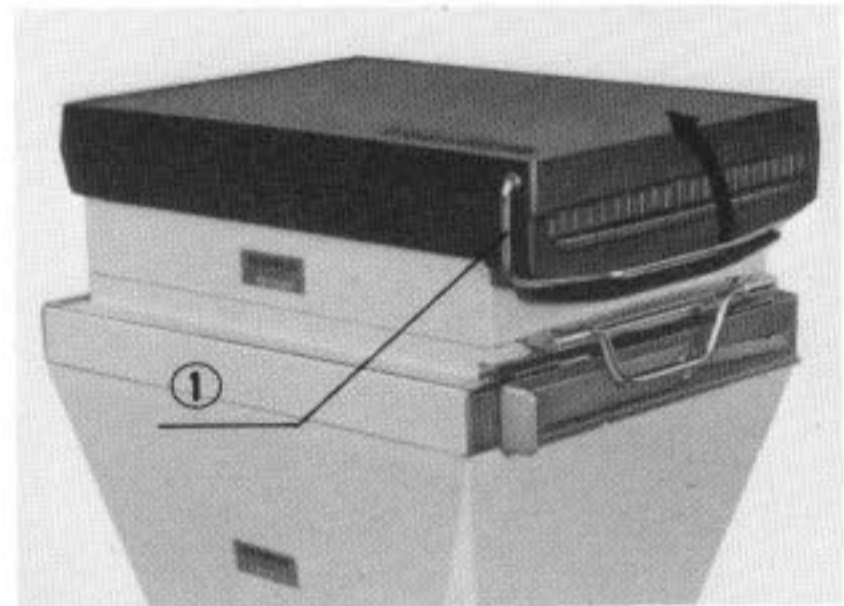

Fig. 28

It is essential to keep the rollers clean, for dirty roller will produce irregularities on the picture.

- 1) To clean the rollers, lift the roller unit ① upwards and remove. (Fig. 29)
- 2) Wipe the rollers first with a wet cloth and then with a dry cloth.
- 3) After cleaning, place the roller unit in its original position.

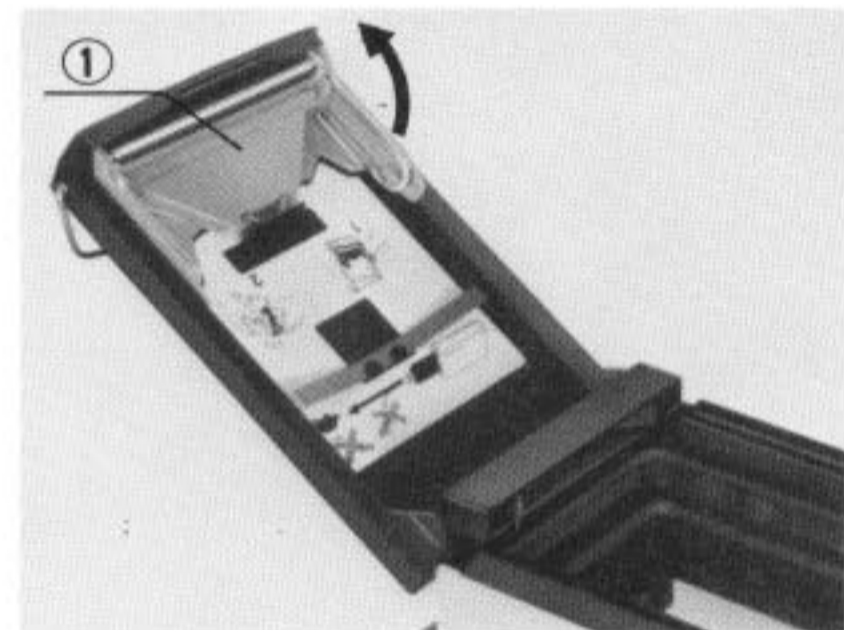

Fig. 29

- 4) Next, holding the film pack only by the edges, so that the safety cover, bearing the legend "SAFETY COVER . . . THIS SIDE FACES LENS", faces into the camera, insert the pack against the spring beneath the back cover. (Fig. 30)
 - 5) Push the pack into the camera until it snaps into place.
- * Make sure that the white tabs are not caught between the pack and the camera body.

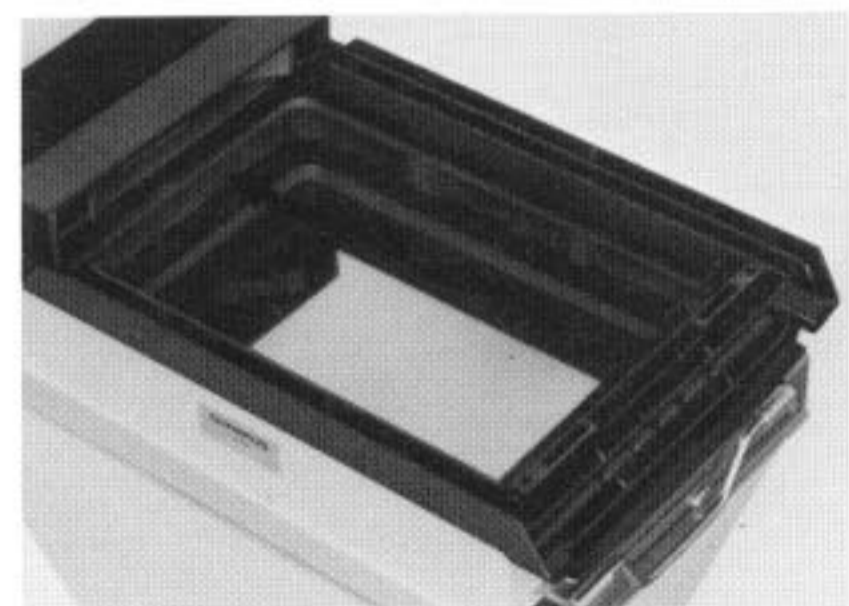

Fig. 30

- 6) Close the camera back cover pressing both sides of the cover tightly. The black tab of the safety cover should protrude from the small slot ; if this is not the case, open the back cover once again and make sure that the black tab is sticking out.
- 7) After the black cover is pulled out, a white tab should emerge from the slot. Pull this white tab only after having made an exposure.

This concludes the preparation for photography.

2. Focusing

- 1) Focus accurately using the focusing telescope or the finder eyepiece in the same manner as with the 35mm camera back.
- 2) For framing, refer to the Polaroid reticle in the focusing telescope or finder eyepiece. Move the specimen target area within the reticle frame.

3. Photography

- 1) Make sure that the mode selector switch of the control unit is set at "AUTO".
- 2) Press the format selector switch "L".
- 3) Match the ASA film speed dial to the speed of the film in use.
- 4) Check the specimen focus once again.
- 5) Make sure that the light path selector knob of the exposure body is in the green band position.
- 6) Make sure that the "SAFETY" light (green) is on.
- 7) Pull the dark slide of the camera back slowly all the way. If not pulled out completely, part of the picture may be obscured.
- 8) Use the release button (EXPOSE) of the control unit to release the shutter. The "WORK" light lights up only while an exposure is in progress.
- 9) After completing the exposure, push the light slide into the camera back.
- 10) Process the film.

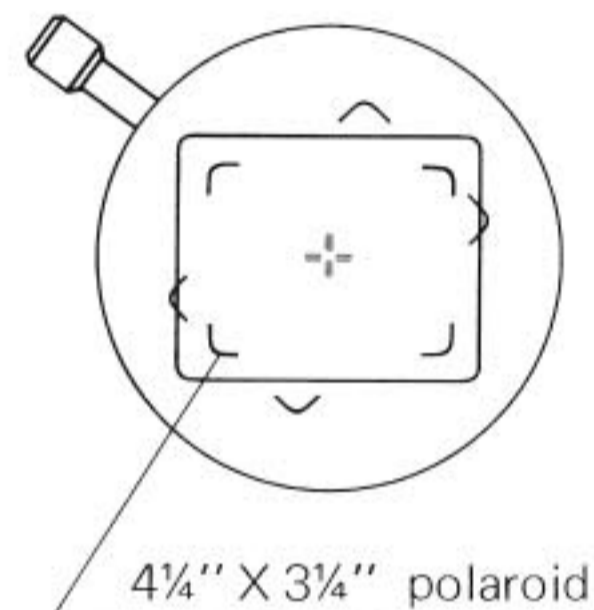

4. Film processing

Develop the film in the following manner :

- 1) Grasp the white tab emerging from the camera with thumb and index finger of the right hand and pull it out completely in one motion.
 - 2) After the white tab is pulled out, a yellow tab emerges.
- * If the yellow tab is in sight, do not pull the white tab.
Pulling out the white tab does not commence development ; it is a preparatory step for pulling the yellow tab.

- 3) Hold the center of the yellow tab and pull it out from the camera quickly in one motion to begin development which starts from the point where the yellow tab has been pulled out all the way.

The speed of pulling should be about equal to the time of saying "pull out". If countless white spots appear in the picture, pull out a little more slowly. Follow the instruction provided with the film for development time.

B. Intermediate Adapter for 4" X 5" Holders

Use of this unit permits photography with 4" X 5" film holders.

1. Attaching large format adapter

Attach in the same manner as described for the 3¼" X 4¼" Polaroid back.

2. Attach the film holder.

- 1) Slide the lock buttons (both sides) of the intermediate adapter in the direction opposite to locking. At the end of their travel press the buttons and the clamping device will lift up. (Fig. 31)

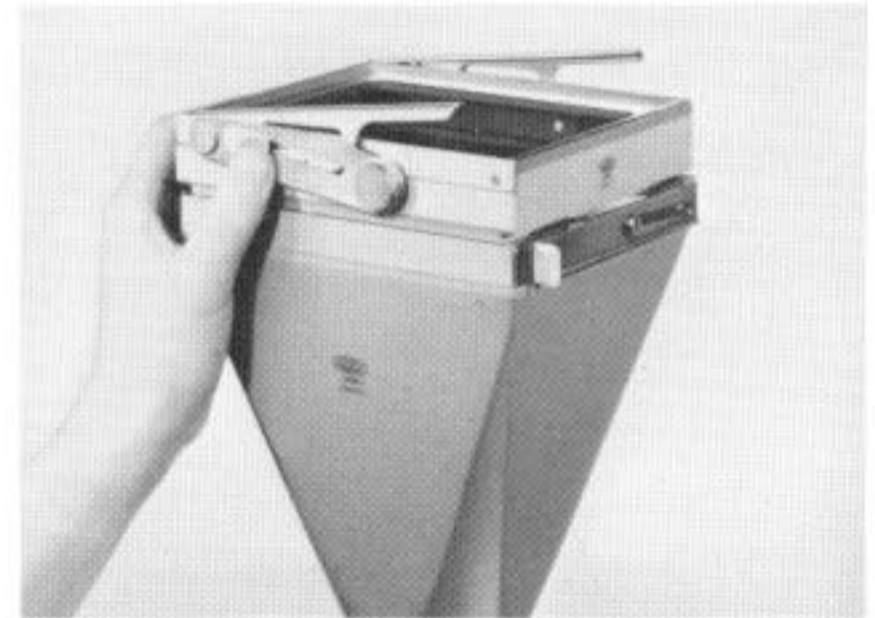

Fig. 31

- 2) Insert the film holder all the way.
This will engage a protrusion on the film holder with a mating groove on the intermediate adapter.
In case of the Graphmatic film holder, the holder can be inserted into position without lifting the clamping device. (Fig. 32)

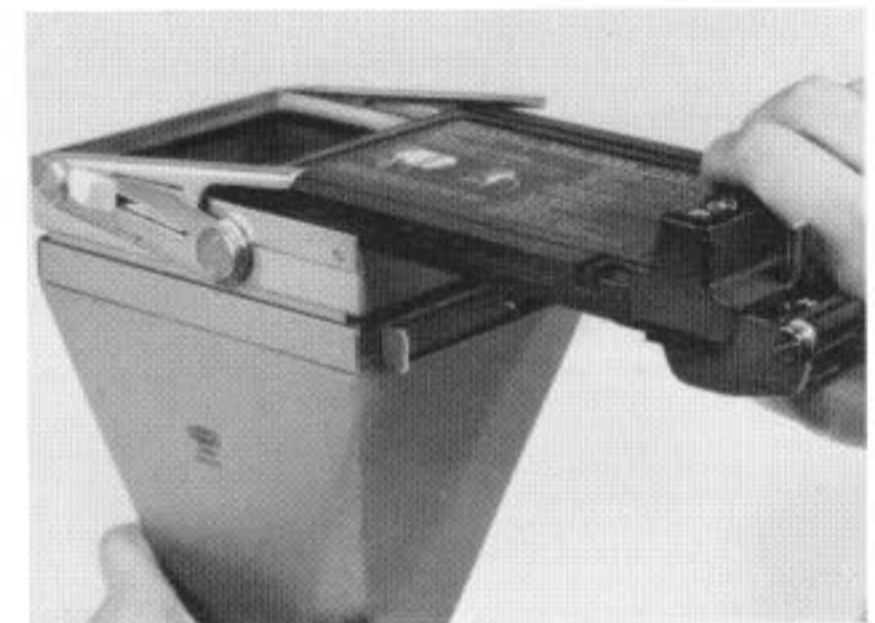

Fig. 32

- 3) Clamp the film holder down with the lock buttons.

© To detach the holder :

- 1) Slide the lock buttons on both sides in the direction opposite to locking.
- 2) The holder slides out easily when lifted lightly. (Fig. 33)

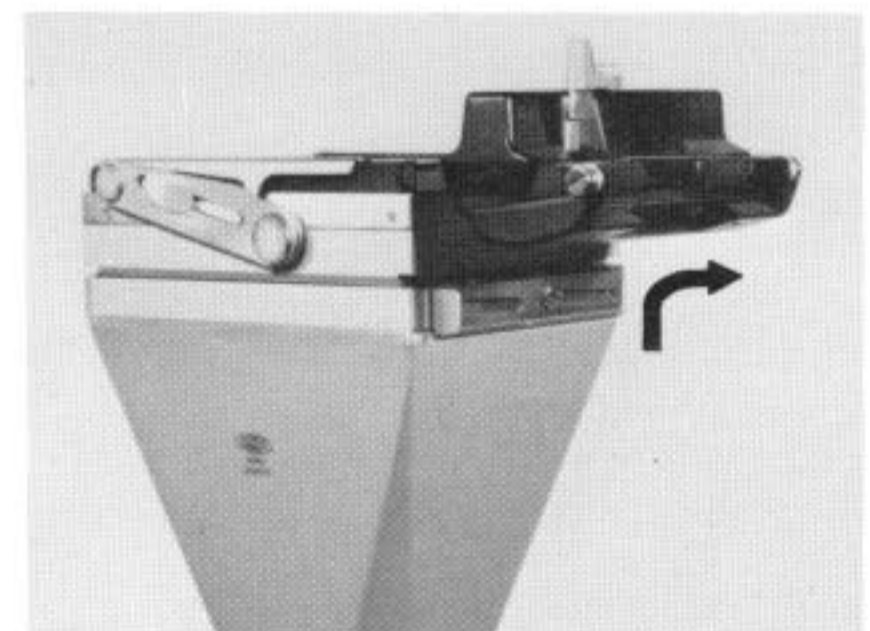
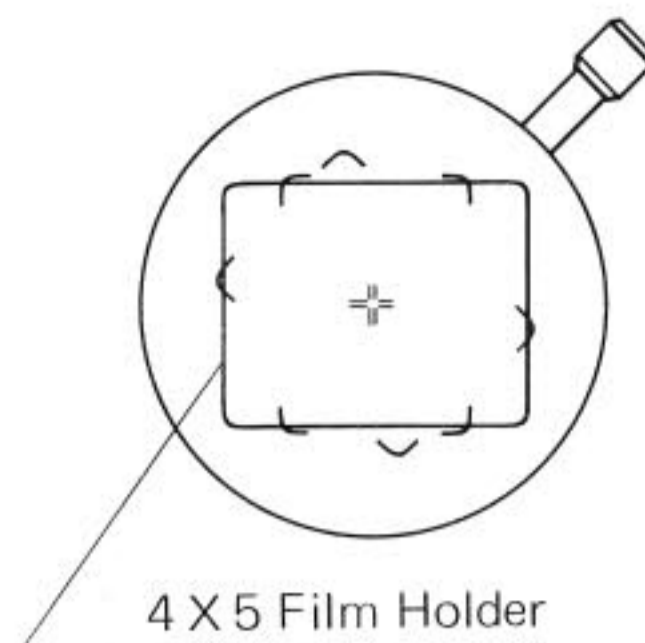

Fig. 33

3. Focusing

- 1) Use the focusing telescope or finder eyepiece to focus, in the same manner as described for the 35mm camera.
- 2) For the film area indication, refer to the 4" X 5" frame reticle in the focusing telescope or finder eyepiece.
Move the desired specimen area within the reticles.



4. Photography

- 1) Make sure that the selector switch of the control unit is set at AUTO.
 - 2) Press the format selector switch "L".
 - 3) Set the ASA film speed dial.
 - 4) Check the specimen focus again.
 - 5) Make sure that the light path selector of the exposure body is in the green band position.
 - 6) Make sure that the "SAFETY" light (green) is on.
 - 7) After pulling out the dark slide (or its equivalent) of the film holder, use the release button to release the shutter.
The WORK light appears only while exposure is in progress.
- ★ For instructions pertaining to the use of the different film holders, please refer to the literature supplied by the individual manufacturers.

VIII. TROUBLESHOOTING GUIDE

If you are unable to obtain 100% performance from your PM-10AD because of unfamiliarity, the table below may provide some pointers.

Phenomenon	Cause	Remedy
1. Preparation		
a) After switching on, no indication appears on display.	Loose electric connection	Check all connections and tighten.
	Short circuit	Contact Olympus repair center.
	Circuit breaker engaged.	Press the circuit breaker button.
b) ISO/ASA indication and exposure adjustment display flash.	The ISO/ASA film speed is set beyond the limits of the working range.	Reset the film speed within the range of the instrument.
c) The exposure time estimated is not displayed immediately.	In case of extremely dark objects, it takes about 5–6 sec. before estimated time is displayed.	Normal.
d) 35mm film cannot be advanced.	"35" format selector switch has not been pressed.	Press the "35" selector switch.
e) When the ISO/ASA film speed dial is set at higher positions, the LED display flashes in warning. Dial settings (for instance): Film format: 35 ISO/ASA dial: 1600 Exp. Adj. dial: 4	The ISO/ASA dial is set beyond the limit of the automatic exposure range, because the exposure range is determined by the formula as follows: Film speed X Exp. Adj. setting. In this case the range should be limited between ISO/ASA 4 and 4000 for 35mm film, and $1600 \times 4 = 6400$ is beyond the limit.	Set the dial within the limit. (Note: High speed film such as ISO/ASA 1000, however, is sometimes not suitable for photomicrography of very small objects that necessitate manual exposure compensation.) In such a case, the AE LOCK or manual mode is recommended.
f) The LED display indicates an exposure time in spite of darkness in the field of view.	1) Extraneous light enters through the viewer, etc. 2) Sometimes the faintest (or inappreciable) light is measured.	Dim the room for long time exposure or set the light path selector knob at "CE".
	High humidity has influence on the light measuring circuit.	Usually it does not matter with photographic results, and the display returns to normal functions as the humidity lowers. If the display still indicates the exposure time, however, under 75% humidity at ISO/ASA 400, it means "out of order" and contact Olympus service personnel for inspection.

Phenomenon	Cause	Remedy
2. Operation		
a) Pressing the exposure button does not actuate the shutter on AUTO mode.	The light path selector knob is set at "VCT".	Reset at "CE" or "CVE".
b) 35mm film cannot be advanced.	The format selector switch is not set at "35".	Reset at "35".
c) Safety light does not light up.	Mode selector switch is set on MANUAL.	Reset at "AUTO".
	The light path selector knob is set at "VCT".	Set at "CE" or "CVE".
	AE LOCK button is on "lock".	Press the lock button.
d) The indicated remaining exposure time does not count down.	No exposure time countdown below 0.5 sec.	Normal
e) Repeated indication of remaining exposure time.	The remaining exposure time is increasing due to specimen discoloration.	Normal
f) Warning tone	Film end light is on, activating the warning tone.	Remove the 35mm camera back and press the film advance button. The warning tone will stop.
	Indicates underexposure with safety light (red) on and with continuous warning tone.	Not enough light. If unable to increase intensity, reset to MANUAL.
	Indicates overexposure with safety light (red) flashing and warning tone.	Too much light. Reduce intensity by means of ND filters or voltage reduction.
g) Color temperature indication light does not light.	Light intensity is insufficient.	Increase intensity.
	Light path selector knob is not set at VCT.	Set at VCT.
h) Two color temperature indication lights light up simultaneously.	The color temperature is on the border.	Normal

Phenomenon	Cause	Remedy
3. Result		
a) Image not sharp.	Dirty lenses	Clean the lens.
	Poor focusing	Complete focusing so that the double cross lines and specimen image can be clearly seen at the same time.
	Aperture iris diaphragm is not correctly adjusted.	Adjust it correctly.
	Standard high dry objectives being used for smear specimens.	Use no-cover objectives.
	Photo eyepiece used is not properly matched with microscope.	Use the photo eyepiece provided with the microscope.
b) No contrast or insufficient resolution	In B & W photography, a proper contrast filter is not being used.	Select a proper filter.
	Aperture iris diaphragm is not properly opened.	Open properly. (Köhler illumination).
	Field iris diaphragm not properly opened.	Open properly. (Köhler illumination).
	Specimen lacks contrast.	Stop down aperture iris diaphragm.
c) Poor color reproduction	Color temperature dial is set incorrectly.	Set color temperature correctly according to film.
	Voltage changed after setting the color temperature.	Vary light intensity by means of ND filters.
	Contrast filter for B & W film is used for color film.	Change filter.
	Reciprocity dial is set incorrectly.	Correctly set according to the instruction sheet.
	CC filter required for the film is not being used.	Use as designated.
d) Under- or overexposure	Incorrect exposure adjustment dial setting.	Set correctly according to specimen density.
	Incorrect reciprocity dial setting.	Correct according to the instruction sheet.
	Incorrect ASA film speed dial setting.	Reset it correctly.

Phenomenon	Cause	Remedy
e) Film is not exposed.	Film is not correctly loaded.	Review the film loading instruction and act accordingly.
	The dark slide is not pulled out in case of large format camera backs.	Pull slide out completely.
f) Only the central portion of film is exposed.	Photo eyepiece is not being used.	Install photo eyepiece.
g) Image is cut off partially at the periphery.	The light path selector knob is between settings.	Click it in position.
	Field iris diaphragm is stopped down excessively.	Do not stop it down to an area less than the frame reticle.
h) No data is imprinted.	Synchro. cord is not connected.	Connect the Recordata Back and exposure body with synchro. cord.
	Recordata Back's on/off switch is off.	Switch on.
	Batteries built in the Recordata Back are exhausted.	Replace.
i) Film advance produces frame overlap.	Film end pushed too far into take-up spool.	Consult page 14, para B3.



OLYMPUS

OLYMPUS OPTICAL CO., LTD.

San-Ei Building, 22-2, Nishi Shinjuku 1-chome, Shinjuku-ku, Tokyo, Japan

OLYMPUS OPTICAL CO., (EUROPA) GMBH.

Postfach 104908, Wendenstrasse 14-16, 2000 Hamburg 1, Germany

OLYMPUS CORPORATION

4 Nevada Drive, Lake Success, N.Y. 11042-1179, U.S.A.

OLYMPUS OPTICAL CO. (U.K.) LTD.

2-8 Honduras Street, London EC1YOTX, United Kingdom

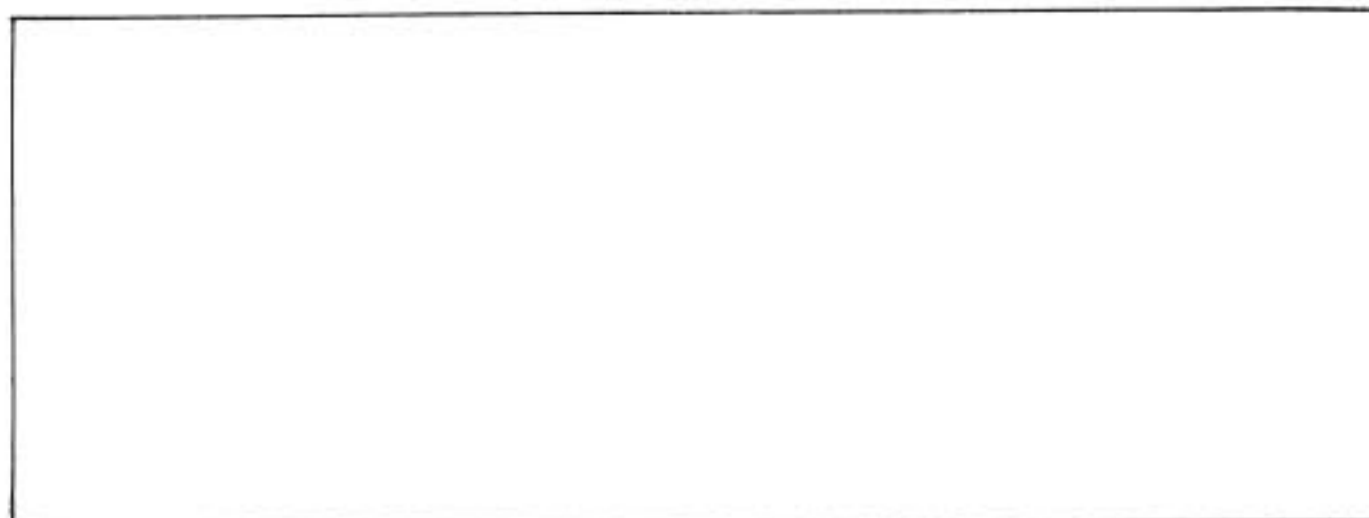

The design of the product is under constant review and whilst every effort is made to keep this manual up to date, the right is reserved to change specifications and equipment at any time without prior notice.